

## D 2 The cool classic one

D 2 is a chair range in a straightforward and clear form of design. A classical free-swinging sub-structure holds the comfortable upholstery. When the Easy-glider function is included, body weight transfer alters the angle of the backrest. The backrest follows the body movements when leaning forward and backward and thus effectively relieves the muscles. This means you can sit comfortably for hours on end.

### Product spectrum

- 2 backrest heights: 85 cm and 97 cm
- 2 different armrests: closed upholstered armrest and all-round metal armrest with an upholstered surface coating
- Optional Easy-glider function: only possible for types with armrest

### Product features

- Tubular steel construction: Ø 2.5 cm
- Backrest and seat: a long-term elastic, full surface rubber spring system provides the basis of the upholstery. This is firmly held in the tubular steel construction and therefore provides perfect sitting comfort.
- Seat upholstery: volume weight of 50 kg/m<sup>3</sup>, form retention: 5 kPa
- Backrest upholstery: volume weight of 30 kg/m<sup>3</sup>, form retention: 4.5 kPa
- Foam of polyurethane
- Plastic and felt gliders are included (for hard and soft floors)



### Metal surfaces

- Aluminium-coloured, powder coated
- High-gloss chrome
- Matt chrome
- Black chrome



### Cover materials

- High-grade leather in contemporary colours
- Microfibre "Dinamica" in homely colours
- Modern textile cover fabrics, easy-to-care for with high-quality protection against soiling
- Customer's fabrics possible (price group = best fabric price group)

### Surface coating of metal armrests

For leather: in the corresponding leather colour  
 For Dinamica: in the corresponding Dinamica colour  
 For velour: in the corresponding velour colour  
 For structured fabric »pure«: in the corresponding structured fabric colour  
 For textile

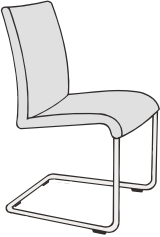
cover fabrics:	in 5105 (black leather) for	6302	6304	6305	6901	8001	8004
	in 5109 (cream leather) for	7501	8002				
	in 5101 (beige leather) for	7502	8201				
	in 5104 (anthracite leather) for	7504	7505	8204	8206	8207	8303
	in 5110 (mocca leather) for	6301	6303	7503	8203	8205	
	in 5114 (grey-brown leather) for	8003					
	in 5122 (sand leather) for	8301					
	in 5123 (brown-black leather) for	8302					

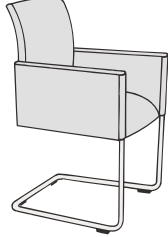
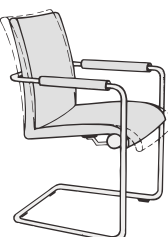
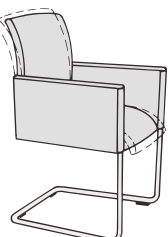
		Structured fabric (63..) Chenille »floral« (69..) Cotton-wool-Jacquard (75..) Woven Jacquard (82..) Woven Jacquard glossy (83..)	Velour CS (62..) Structured fabric »pure« (77..)	Leather (51..) »Dinamica« (68..) Wool fabric (80..)	Saddle leather (65..) Leather »metallic« (79..)
 <p><b>D 2-1</b></p> <p><b>Free-swinging chair with low backrest</b></p> <p>Substructure versions: aluminium-coloured, powder coated / high-gloss/matt/black chrome</p> <p>Total height: 85 cm Total width: 49 cm Total depth: 59 cm Seat height: 48.5 cm Seat width: 48:46 cm Seat depth: 48 cm Fabric req.: 1.1 m Leather req.: 2.0 m²</p>	Substructure version: aluminium-coloured, powder coated	D 211.... -	D 211.... -	D 211.... -	D 211.... -
	Substructure version: High-gloss chrome	D 212.... -	D 212.... -	D 212.... -	D 212.... -
	Substructure version: Matt chrome	D 213.... -	D 213.... -	D 213.... -	D 213.... -
	Substructure version: Black chrome	D 214.... -	D 214.... -	D 214.... -	D 214.... -
 <p><b>D 2-2</b></p> <p><b>Free-swinging chair with low backrest and with metal armrests and upholstery</b></p> <p>Substructure versions: aluminium-coloured, powder coated / high-gloss/matt/black chrome</p> <p>Total height: 85 cm Total width: 55 cm Total depth: 59 cm Seat height: 48.5 cm Seat width: 47:44.5 cm Seat depth: 46 cm Armrest height: 64 cm Fabric req.: 1.2 m Leather req.: 2.0 m²</p>	Substructure version: aluminium-coloured, powder coated	D 221.... -	D 221.... -	D 221.... -	D 221.... -
	Substructure version: High-gloss chrome	D 222.... -	D 222.... -	D 222.... -	D 222.... -
	Substructure version: Matt chrome	D 223.... -	D 223.... -	D 223.... -	D 223.... -
	Substructure version: Black chrome	D 224.... -	D 224.... -	D 224.... -	D 224.... -
 <p><b>D 2-3</b></p> <p><b>Free-swinging chair with low backrest and upholstered armrests</b></p> <p>Substructure versions: aluminium-coloured, powder coated / high-gloss/matt/black chrome</p> <p>Total height: 85 cm Total width: 56 cm Total depth: 59 cm Seat height: 48.5 cm Seat width: 47:44.5 cm Seat depth: 46 cm Armrest height: 64 cm Fabric req.: 1.8 m Leather req.: 3.2 m²</p>	Substructure version: aluminium-coloured, powder coated	D 231.... -	D 231.... -	D 231.... -	D 231.... -
	Substructure version: High-gloss chrome	D 232.... -	D 232.... -	D 232.... -	D 232.... -
	Substructure version: Matt chrome	D 233.... -	D 233.... -	D 233.... -	D 233.... -
	Substructure version: Black chrome	D 234.... -	D 234.... -	D 234.... -	D 234.... -
 <p><b>D 2-4</b></p> <p><b>Free-swinging chair with low backrest and with metal armrests/Easy glider</b></p> <p>Substructure versions: aluminium-coloured, powder coated / high-gloss/matt/black chrome</p> <p>Total height: 85 cm Total width: 55 cm Total depth: 59 cm Seat height: 48.5 cm Seat width: 47:44.5 cm Seat depth: 46 cm Armrest height: 64 cm Fabric req.: 1.3 m Leather req.: 2.0 m²</p>	Substructure version: aluminium-coloured, powder coated	D 241.... -	D 241.... -	D 241.... -	D 241.... -
	Substructure version: High-gloss chrome	D 242.... -	D 242.... -	D 242.... -	D 242.... -
	Substructure version: Matt chrome	D 243.... -	D 243.... -	D 243.... -	D 243.... -
	Substructure version: Black chrome	D 244.... -	D 244.... -	D 244.... -	D 244.... -
 <p><b>D 2-5</b></p> <p><b>Free-swinging chair with low backrest and with upholstered armrests/Easy glider</b></p> <p>Substructure versions: aluminium-coloured, powder coated / high-gloss/matt/black chrome</p> <p>Total height: 85 cm Total width: 56 cm Total depth: 59 cm Seat height: 48.5 cm Seat width: 47:44.5 cm Seat depth: 46 cm Armrest height: 64 cm Fabric req.: 1.8 m Leather req.: 3.2 m²</p>	Substructure version: aluminium-coloured, powder coated	D 251.... -	D 251.... -	D 251.... -	D 251.... -
	Substructure version: High-gloss chrome	D 252.... -	D 252.... -	D 252.... -	D 252.... -
	Substructure version: Matt chrome	D 253.... -	D 253.... -	D 253.... -	D 253.... -
	Substructure version: Black chrome	D 254.... -	D 254.... -	D 254.... -	D 254.... -

# CHAIRS D 2

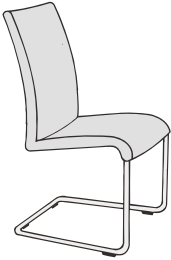
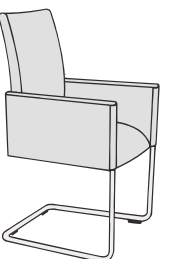
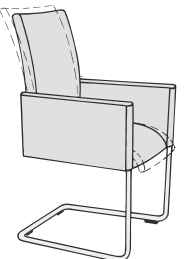
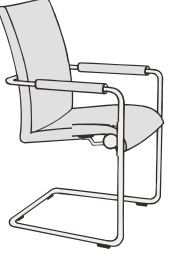
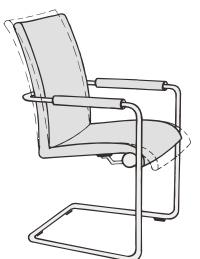
		Structured fabric (63..) Chenille »floral« (69..) Cotton-wool-Jacquard (75..) Woven Jacquard (82..) Woven Jacquard glossy (83..)	Velour CS (62..) Structured fabric »pure« (77..)	Leather (51..) »Dinamica« (68..) Wool fabric (80..)	Saddle leather (65..) Leather »metallic« (79..)
 <p><b>D 2-6</b> Free-swinging chair with high backrest</p> <p>Substructure versions: aluminium-coloured, powder coated / high-gloss/matt/black chrome            Total height: 97 cm            Total width: 49 cm            Total depth: 63.5 cm            Seat height: 48.5 cm            Seat width: 49:45 cm            Seat depth: 46 cm            Fabric req.: 1.1 m            Leather req.: 2.1 m<sup>2</sup></p>	Substructure version: aluminium-coloured, powder coated	D 261....	D 261....	D 261....	D 261....
	Substructure version: High-gloss chrome	D 262....	D 262....	D 262....	D 262....
	Substructure version: Matt chrome	D 263....	D 263....	D 263....	D 263....
	Substructure version: Black chrome	D 264....	D 264....	D 264....	D 264....
 <p><b>D 2-7</b> Free-swinging chair with high backrest and with upholstered armrests</p> <p>Substructure versions: aluminium-coloured, powder coated / high-gloss/matt/black chrome            Total height: 97 cm            Total width: 56 cm            Total depth: 64 cm            Seat height: 48.5 cm            Seat width: 47:44 cm            Seat depth: 46 cm            Armrest height: 64 cm            Fabric req.: 1.8 m            Leather req.: 3.5 m<sup>2</sup></p>	Substructure version: aluminium-coloured, powder coated	D 271....	D 271....	D 271....	D 271....
	Substructure version: High-gloss chrome	D 272....	D 272....	D 272....	D 272....
	Substructure version: Matt chrome	D 273....	D 273....	D 273....	D 273....
	Substructure version: Black chrome	D 274....	D 274....	D 274....	D 274....
 <p><b>D 2-8</b> Free-swinging chair with high backrest and with upholstered armrests/Easy glider</p> <p>Substructure versions: aluminium-coloured, powder coated / high-gloss/matt/black chrome            Total height: 97 cm            Total width: 56 cm            Total depth: 64 cm            Seat height: 48.5 cm            Seat width: 47:44 cm            Seat depth: 46 cm            Armrest height: 64 cm            Fabric req.: 1.8 m            Leather req.: 3.5 m<sup>2</sup></p>	Substructure version: aluminium-coloured, powder coated	D 281....	D 281....	D 281....	D 281....
	Substructure version: High-gloss chrome	D 282....	D 282....	D 282....	D 282....
	Substructure version: Matt chrome	D 283....	D 283....	D 283....	D 283....
	Substructure version: Black chrome	D 284....	D 284....	D 284....	D 284....
 <p><b>D 2-9</b> Free-swinging chair with high backrest and with metal armrests and upholstery</p> <p>Substructure versions: aluminium-coloured, powder coated / high-gloss/matt/black chrome            Total height: 97 cm            Total width: 55 cm            Total depth: 63 cm            Seat height: 48.5 cm            Seat width: 47:44 cm            Seat depth: 46 cm            Armrest height: 64 cm            Fabric req.: 1.3 m            Leather req.: 2.2 m<sup>2</sup></p>	Substructure version: aluminium-coloured, powder coated	D 291....	D 291....	D 291....	D 291....
	Substructure version: High-gloss chrome	D 292....	D 292....	D 292....	D 292....
	Substructure version: Matt chrome	D 293....	D 293....	D 293....	D 293....
	Substructure version: Black chrome	D 294....	D 294....	D 294....	D 294....
 <p><b>D 2-10</b> Free-swinging chair with high backrest and with metal armrests/Easy glider</p> <p>Substructure versions: aluminium-coloured, powder coated / high-gloss/matt/black chrome            Total height: 97 cm            Total width: 55 cm            Total depth: 63 cm            Seat height: 48.5 cm            Seat width: 47:44 cm            Seat depth: 46 cm            Armrest height: 64 cm            Fabric req.: 1.3 m            Leather req.: 2.2 m<sup>2</sup></p>	Substructure version: aluminium-coloured, powder coated	D 2101....	D 2101....	D 2101....	D 2101....
	Substructure version: High-gloss chrome	D 2102....	D 2102....	D 2102....	D 2102....
	Substructure version: Matt chrome	D 2103....	D 2103....	D 2103....	D 2103....
	Substructure version: Black chrome	D 2104....	D 2104....	D 2104....	D 2104....



## D 4 The comfy classic one

A clear and straightforward design form as well as high-grade details in design and workmanship are the hallmarks of this model. The D4 model family also includes high chairs, which are especially suitable as bar stools, and numerous benches, besides the classic dining room chairs.

### Product spectrum

- 2 backrest heights: 81 cm and 92 cm
- 2 different armrests: closed upholstered armrest (for the D 4-2) and wooden armrest
- Bar stool with 2 seat heights: 65 cm and 80 cm

### Product features

- Substructure construction of solid wood
- Seat and backrest: a long-term elastic, woven, rubber spring system provides the basis of the upholstery. The belts are firmly held in the solid wooden substructure.
- Seat foam RG 5560 HR
- Foam of polyurethane
- Solid wooden legs
- Plastic and felt gliders are included (for hard and soft floors)



### Cover materials

- High-grade leather in contemporary colours
- Microfibre "Dinamica" in homely colours
- Modern textile cover fabrics, easy-to-care for with high-quality protection against soiling
- Customer's fabrics possible (price group = best fabric price group)

### List of versions Substructure

Model no.	Version
110	Solid beech
111	Solid alder
112	Solid natural maple
113	Solid Cherrywood gold
115	Solid oak mocca
116	Solid oak anthracite
117	Solid natural oak
122	Solid light brown ash
118	Solid walnut

Please be sure to state the **model no. of the substructure wood version** in your order!

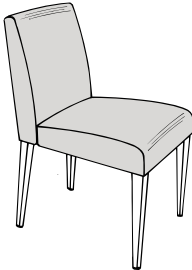
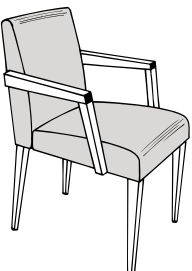
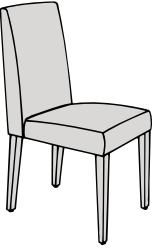
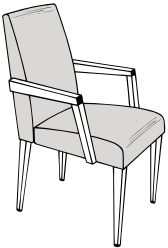
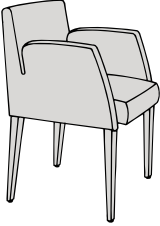
		Structured fabric (63..) Chenille »floral« (69..) Cotton-wool-Jacquard (75..) Woven Jacquard (82..) Woolen Jacquard glossy (83..)	Velour CS (62..) Structured fabric »pure« (77..)	Leather (51..) »Dinamica« (68..) Wool fabric (80..)	Saddle leather (65..) Leather »metallic« (79..)
 <p><b>D 4-4</b> Upholstered chair with low backrest</p> <p>Total height: 81 cm Total width: 46 cm Total depth: 60 cm Seat height: 49 cm Seat width: 46:42 cm Seat depth: 45 cm Fabric req.: 1.1 m Leather req.: 1.88 m<sup>2</sup></p>					
		D 44....	D 44....	D 44....	D 44....
 <p><b>D 4-5</b> Upholstered chair with low backrest and with wooden armrests</p> <p>Total height: 81 cm Total width: 55 cm Total depth: 60 cm Seat height: 49 cm Seat width: 46:42 cm Seat depth: 45 cm Armrest height: max. 65.5 cm Fabric req.: 1.1 m Leather req.: 1.88 m<sup>2</sup></p>					
		D 45....	D 45....	D 45....	D 45....
 <p><b>D 4-1</b> Upholstered chair with high backrest</p> <p>Total height: 92 cm Total width: 46 cm Total depth: 60 cm Seat height: 49 cm Seat width: 46:42 cm Seat depth: 45 cm Fabric req.: 1.3 m Leather req.: 2.2 m<sup>2</sup></p>					
		D 41....	D 41....	D 41....	D 41....
 <p><b>D 4-3</b> Upholstered chair with high backrest and with wooden armrests</p> <p>Total height: 92 cm Total width: 55 cm Total depth: 60 cm Seat height: 49 cm Seat width: 46:42 cm Seat depth: 45 cm Armrest height: max. 65.5 cm Fabric req.: 1.25 m Leather req.: 2.13 m<sup>2</sup></p>					
		D 43....	D 43....	D 43....	D 43....
 <p><b>D 4-2</b> Upholstered chair with upholstered armrests</p> <p>Total height: 81 cm Total width: 59 cm Total depth: 59 cm Seat height: 48.5 cm Seat width: 46:43 cm Seat depth: 46 cm Armrest height: 66.5 cm Fabric req.: 1.8 m Leather req.: 3.1 m<sup>2</sup></p>					
		D 42....	D 42....	D 42....	D 42....
		Beech			
		Alder			
		Natural maple			
		Oak mocca/ anthracite/ natural oak/ light brown ash			
		Cherrywood gold			
		Walnut			

# CHAIRS D 4

Please be sure to state the **model no. of the substructure wood version** in your order!

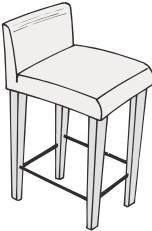
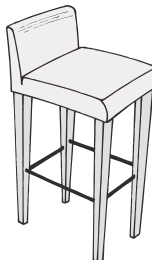
		Structured fabric (63..) Chenille »floral« (69..) Cotton-wool-Jacquard (75..) Woven Jacquard (82..) Woven Jacquard glossy (83..)	Velour CS (62..) Structured fabric »pure« (77..)	Leather (51..) »Dinamica« (68..) Wool fabric (80..)	Saddle leather (65..) Leather »metallic« (79..)
 <p><b>D 4-7</b> High chair seat height 65 cm</p> <p>Total height: 82 cm Total width: 38 cm Total depth: 43 cm Seat height: 65 cm Seat width: 37 cm Seat depth: 37 cm Fabric req.: 0.6 m Leather req.: 0.85 m<sup>2</sup></p>		<b>D 47....</b>	<b>D 47....</b>	<b>D 47....</b>	<b>D 47....</b>
	<p><b>Beech</b> - - - -</p> <p><b>Alder</b> - - - -</p> <p><b>Natural maple</b> - - - -</p> <p><b>Oak mocca/ anthracite/ natural oak/ light brown ash</b> - - - -</p> <p><b>Cherrywood gold</b> - - - -</p> <p><b>Walnut</b> - - - -</p>		<b>D 48....</b>	<b>D 48....</b>	<b>D 48....</b>
 <p><b>D 4-8</b> High chair seat height 80 cm</p> <p>Total height: 97 cm Total width: 38 cm Total depth: 43 cm Seat height: 80 cm Seat width: 37 cm Seat depth: 37 cm Fabric req.: 0.6 m Leather req.: 0.85 m<sup>2</sup></p>		<b>D 48....</b>	<b>D 48....</b>	<b>D 48....</b>	<b>D 48....</b>
	<p><b>Beech</b> - - - -</p> <p><b>Alder</b> - - - -</p> <p><b>Natural maple</b> - - - -</p> <p><b>Oak mocca/ anthracite/ natural oak/ light brown ash</b> - - - -</p> <p><b>Cherrywood gold</b> - - - -</p> <p><b>Walnut</b> - - - -</p>				

# D 4-Bench

The comfy classic one as a bench

A clear and straightforward design form as well as high-grade details in design and workmanship are the hallmarks of our "classic" D4. A small family of benches has now been developed in this timeless classic design.

## Product spectrum

- Benches in 4 widths, with 2 backrest heights and with 1 armrest version:
  - Widths: 140, 160, 180 cm and 200 cm
  - Heights: 83 cm and 92.5 cm
  - Armrest: Wooden armrest in the matching wood version



## Product features

- Substructure construction of solid wood
- Seat and backrest: a long-term elastic, woven, rubber spring system provides the basis of the upholstery. The belts are firmly held in the solid wooden substructure.
- Seat foam RG 5560 HR
- Foam of polyurethane
- Solid wooden legs
- Plastic and felt gliders are included (for hard and soft floors)

## Cover materials

- High-grade leather in contemporary colours
- Microfibre "Dinamica" in homely colours
- Modern textile cover fabrics, easy-to-care for with high-quality protection against soiling
- Customer's fabrics possible (price group = best fabric price group)

## List of versions Substructure

Model no.	Version
110	Solid beech
111	Solid alder
112	Solid natural maple
113	Solid Cherrywood gold
115	Solid oak mocca
116	Solid oak anthracite
117	Solid natural oak
122	Solid light brown ash
118	Solid walnut

Please be sure to state the **model no. of the substructure wood version** in your order!

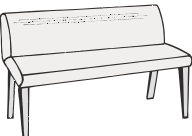
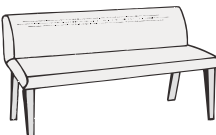
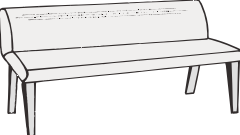
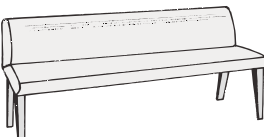

# BENCHES D 4 with backrest height 83 cm

		Structured fabric (63..) Chenille »floral« (69..) Cotton-wool-Jacquard (75..) Woven Jacquard (82..) Woolen Jacquard glossy (83..)	Velour CS (62..) Structured fabric »pure« (77..)	Leather (51..) »Dinamica« (68..) Wool fabric (80..)	Saddle leather (65..) Leather »metallic« (79..)
 <p><b>D 4-21</b> Bench with backrest height 83 cm without armrests 140 cm wide</p> <p>Total height: 83 cm Total width: 140 cm Total depth: 61 cm Seat height: 48 cm Seat width: 140 cm Seat depth: 44 cm Fabric req.: 2.95 m<sup>2</sup> Leather req.: 4.4 m<sup>2</sup></p>					
		D 421....	D 421....	D 421....	D 421....
	Beech Alder Natural maple Oak mocca/ anthracite/ natural oak/ light brown ash Cherrywood gold Walnut	- - - - - - -	- - - - - - -	- - - - - - -	- - - - - - -
 <p><b>D 4-9</b> Bench with backrest height 83 cm without armrests 160 cm wide</p> <p>Total height: 83 cm Total width: 160 cm Total depth: 61 cm Seat height: 48 cm Seat width: 160 cm Seat depth: 44 cm Fabric req.: 2.95 m<sup>2</sup> Leather req.: 5.0 m<sup>2</sup></p>					
		D 49....	D 49....	D 49....	D 49....
	Beech Alder Natural maple Oak mocca/ anthracite/ natural oak/ light brown ash Cherrywood gold Walnut	- - - - - - -	- - - - - - -	- - - - - - -	- - - - - - -
 <p><b>D 4-23</b> Bench with backrest height 83 cm without armrests 180 cm wide</p> <p>Total height: 83 cm Total width: 180 cm Total depth: 61 cm Seat height: 48 cm Seat width: 180 cm Seat depth: 44 cm Fabric req.: 2.95 m<sup>2</sup> Leather req.: 5.76 m<sup>2</sup></p>					
		D 423....	D 423....	D 423....	D 423....
	Beech Alder Natural maple Oak mocca/ anthracite/ natural oak/ light brown ash Cherrywood gold Walnut	- - - - - - -	- - - - - - -	- - - - - - -	- - - - - - -
 <p><b>D 4-11</b> Bench with backrest height 83 cm without armrests 200 cm wide</p> <p>Total height: 83 cm Total width: 200 cm Total depth: 61 cm Seat height: 48 cm Seat width: 200 cm Seat depth: 44 cm Fabric req.: 3.6 m<sup>2</sup> Leather req.: 6.5 m<sup>2</sup></p>					
		D 411....	D 411....	D 411....	D 411....
	Beech Alder Natural maple Oak mocca/ anthracite/ natural oak/ light brown ash Cherrywood gold Walnut	- - - - - - -	- - - - - - -	- - - - - - -	- - - - - - -

# BENCHES D 4 with backrest height 92.5 cm

Please be sure to state the **model no. of the substructure wood version** in your order!

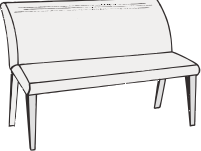
# DINING ROOMS

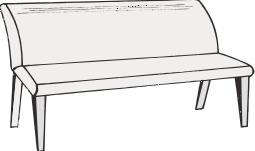
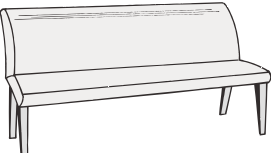
		Structured fabric (63..) Chenille »floral« (69..) Cotton-wool-Jacquard (75..) Woven Jacquard (82..) Woolen Jacquard glossy (83..)	Velour CS (62..) Structured fabric »pure« (77..)	Leather (51..) »Dinamica« (68..) Wool fabric (80..)	Saddle leather (65..) Leather »metallic« (79..)
 <p><b>D 4-22</b> Bench with backrest height 92.5 cm without armrests 140 cm wide</p> <p>Total height: 92.5 cm Total width: 140 cm Total depth: 61 cm Seat height: 48 cm Seat width: 140 cm Seat depth: 44 cm Fabric req.: 3.2 m Leather req.: 4.92 m<sup>2</sup></p>		D 422....	D 422....	D 422....	D 422....
	<p>Beech - Alder - Natural maple - Oak mocca/ anthracite/ natural oak/ light brown ash - Cherrywood gold - Walnut -</p>	- - - - - - -	- - - - - - -	- - - - - - -	- - - - - - -
 <p><b>D 4-10</b> Bench with backrest height 92.5 cm without armrests 160 cm wide</p> <p>Total height: 92.5 cm Total width: 160 cm Total depth: 61 cm Seat height: 48 cm Seat width: 160 cm Seat depth: 44 cm Fabric req.: 3.2 m Leather req.: 5.75 m<sup>2</sup></p>		D 410....	D 410....	D 410....	D 410....
	<p>Beech - Alder - Natural maple - Oak mocca/ anthracite/ natural oak/ light brown ash - Cherrywood gold - Walnut -</p>	- - - - - - -	- - - - - - -	- - - - - - -	- - - - - - -
 <p><b>D 4-24</b> Bench with backrest height 92.5 cm without armrests 180 cm wide</p> <p>Total height: 92.5 cm Total width: 180 cm Total depth: 61 cm Seat height: 48 cm Seat width: 180 cm Seat depth: 44 cm Fabric req.: 3.2 m Leather req.: 6.3 m<sup>2</sup></p>		D 424....	D 424....	D 424....	D 424....
	<p>Beech - Alder - Natural maple - Oak mocca/ anthracite/ natural oak/ light brown ash - Cherrywood gold - Walnut -</p>	- - - - - - -	- - - - - - -	- - - - - - -	- - - - - - -
 <p><b>D 4-12</b> Bench with backrest height 92.5 cm without armrests 200 cm wide</p> <p>Total height: 92.5 cm Total width: 200 cm Total depth: 61 cm Seat height: 48 cm Seat width: 200 cm Seat depth: 44 cm Fabric req.: 3.7 m Leather req.: 7.5 m<sup>2</sup></p>		D 412....	D 412....	D 412....	D 412....
	<p>Beech - Alder - Natural maple - Oak mocca/ anthracite/ natural oak/ light brown ash - Cherrywood gold - Walnut -</p>	- - - - - - -	- - - - - - -	- - - - - - -	- - - - - - -

Please be sure to state the **model no. of the substructure wood version** in your order!

# BENCHES D 4 with backrest height 83 cm

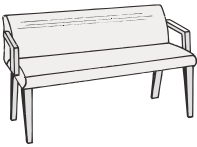
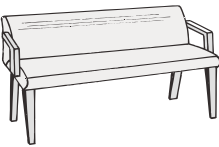
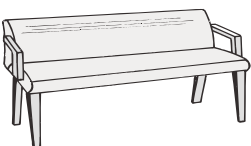
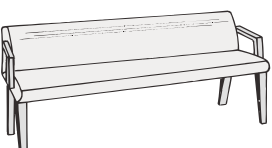
		Structured fabric (63..) Chenille »floral« (69..) Cotton-wool-Jacquard (75..) Woven Jacquard (82..) Wool fabric glossy (83..)	Velour CS (62..) Structured fabric »pure« (77..)	Leather (51..) »Dinamica« (68..) Wool fabric (80..)	Saddle leather (65..) Leather »metallic« (79..)
 <p><b>D 4-25</b> Bench with backrest height 83 cm with wooden armrests 140 cm wide</p> <p>Total height: 83 cm Total width: 146 cm Total depth: 61 cm Seat height: 48 cm Seat width: 138 cm Seat depth: 44 cm Fabric req.: 2.95 m Leather req.: 4.4 m<sup>2</sup></p>		D 425....	D 425....	D 425....	D 425....
	<p>Beech - - - -</p> <p>Alder - - - -</p> <p>Natural maple - - - -</p> <p>Oak mocca/ anthracite/ natural oak/ light brown ash - - - -</p> <p>Cherrywood gold - - - -</p> <p>Walnut - - - -</p>				
 <p><b>D 4-13</b> Bench with backrest height 83 cm with wooden armrests 160 cm wide</p> <p>Total height: 83 cm Total width: 166 cm Total depth: 61 cm Seat height: 48 cm Seat width: 158 cm Seat depth: 44 cm Fabric req.: 2.95 m Leather req.: 5.0 m<sup>2</sup></p>		D 413....	D 413....	D 413....	D 413....
	<p>Beech - - - -</p> <p>Alder - - - -</p> <p>Natural maple - - - -</p> <p>Oak mocca/ anthracite/ natural oak/ light brown ash - - - -</p> <p>Cherrywood gold - - - -</p> <p>Walnut - - - -</p>				
 <p><b>D 4-27</b> Bench with backrest height 83 cm with wooden armrests 180 cm wide</p> <p>Total height: 83 cm Total width: 186 cm Total depth: 61 cm Seat height: 48 cm Seat width: 178 cm Seat depth: 44 cm Fabric req.: 2.95 m Leather req.: 5.76 m<sup>2</sup></p>		D 427....	D 427....	D 427....	D 427....
	<p>Beech - - - -</p> <p>Alder - - - -</p> <p>Natural maple - - - -</p> <p>Oak mocca/ anthracite/ natural oak/ light brown ash - - - -</p> <p>Cherrywood gold - - - -</p> <p>Walnut - - - -</p>				
 <p><b>D 4-15</b> Bench with backrest height 83 cm with wooden armrests 200 cm wide</p> <p>Total height: 83 cm Total width: 206 cm Total depth: 61 cm Seat height: 48 cm Seat width: 198 cm Seat depth: 44 cm Fabric req.: 3.6 m Leather req.: 6.5 m<sup>2</sup></p>		D 415....	D 415....	D 415....	D 415....
	<p>Beech - - - -</p> <p>Alder - - - -</p> <p>Natural maple - - - -</p> <p>Oak mocca/ anthracite/ natural oak/ light brown ash - - - -</p> <p>Cherrywood gold - - - -</p> <p>Walnut - - - -</p>				

# BENCHES D 4 with backrest height 92.5 cm

Please be sure to state the **model no. of the substructure wood version** in your order!

# DINING ROOMS

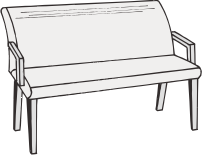
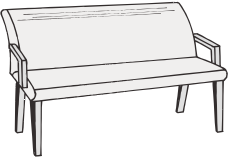
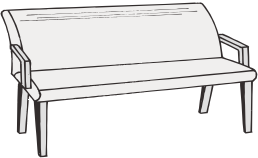
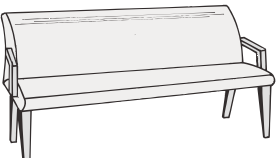
		Structured fabric (63..) Chenille »floral« (69..) Cotton-wool-Jacquard (75..) Woven Jacquard (82..) Woolen Jacquard glossy (83..)	Velour CS (62..) Structured fabric »pure« (77..)	Leather (51..) »Dinamica« (68..) Wool fabric (80..)	Saddle leather (65..) Leather »metallic« (79..)
 <p><b>D 4-26</b> Bench with backrest height 92.5 cm with wooden armrests 140 cm wide</p> <p>Total height: 92.5 cm Total width: 146 cm Total depth: 61 cm Seat height: 48 cm Seat width: 138 cm Seat depth: 44 cm Fabric req.: 3.2 m Leather req.: 4.92 m<sup>2</sup></p>		D 426....	D 426....	D 426....	D 426....
	<p>Beech -</p> <p>Alder -</p> <p>Natural maple -</p> <p>Oak mocca/ anthracite/ natural oak/ light brown ash -</p> <p>Cherrywood gold -</p> <p>Walnut -</p>	-	-	-	-
 <p><b>D 4-14</b> Bench with backrest height 92.5 cm with wooden armrests 160 cm wide</p> <p>Total height: 92.5 cm Total width: 166 cm Total depth: 61 cm Seat height: 48 cm Seat width: 158 cm Seat depth: 44 cm Fabric req.: 3.2 m Leather req.: 5.75 m<sup>2</sup></p>		D 414....	D 414....	D 414....	D 414....
	<p>Beech -</p> <p>Alder -</p> <p>Natural maple -</p> <p>Oak mocca/ anthracite/ natural oak/ light brown ash -</p> <p>Cherrywood gold -</p> <p>Walnut -</p>	-	-	-	-
 <p><b>D 4-28</b> Bench with backrest height 92.5 cm with wooden armrests 180 cm wide</p> <p>Total height: 92.5 cm Total width: 186 cm Total depth: 61 cm Seat height: 48 cm Seat width: 178 cm Seat depth: 44 cm Fabric req.: 3.2 m Leather req.: 6.3 m<sup>2</sup></p>		D 428....	D 428....	D 428....	D 428....
	<p>Beech -</p> <p>Alder -</p> <p>Natural maple -</p> <p>Oak mocca/ anthracite/ natural oak/ light brown ash -</p> <p>Cherrywood gold -</p> <p>Walnut -</p>	-	-	-	-
 <p><b>D 4-16</b> Bench with backrest height 92.5 cm with wooden armrests 200 cm wide</p> <p>Total height: 92.5 cm Total width: 206 cm Total depth: 61 cm Seat height: 48 cm Seat width: 198 cm Seat depth: 44 cm Fabric req.: 3.7 m Leather req.: 7.5 m<sup>2</sup></p>		D 416....	D 416....	D 416....	D 416....
	<p>Beech -</p> <p>Alder -</p> <p>Natural maple -</p> <p>Oak mocca/ anthracite/ natural oak/ light brown ash -</p> <p>Cherrywood gold -</p> <p>Walnut -</p>	-	-	-	-

# D 5 The snugly one

A formed wooden bowl that embraces the body, comfortably upholstered, all on a delicate four-legged or on an arched substructure, is what makes this model so attractive. The wide variety of combinations of wood-/lacquer surfaces and for the surface of the bowl and the covers of the inside bowl make it into a real “chameleon”. The armchair is suitable for use in living as well as in dining rooms, as well as for professional use.

**Product features**

- 2 different substructures
- 2 large surface formed wooden bowls together form the outer section of this model and stabilise themselves mutually
- Outer veneer of fine wood or in white lacquer
- Interior bowl upholstery: backrest and seat are upholstered as one unit to leave no seams. These are then exactly fitted into the outer bowl.
- Seat and backrest upholstery: volume weight of 50 kg/m³ and a form retention of 5.0 kPa
- Foam of polyurethane
- Plastic and felt gliders are included (for hard and soft floors)



**Metal surfaces**

- Aluminium-coloured, powder coated
- High-gloss chrome
- Matt chrome
- Black chrome

**Cover materials**

- High-grade leather in contemporary colours
- Microfibre “Dinamica” in homely colours
- Modern textile cover fabrics, easy-to-care for with high-quality protection against soiling
- Customer’s fabrics possible (price group = best fabric price group)



**List of versions Formed wooden seat**

Model no.	Version	Price group
110	Beech	I
112	Natural maple	II
115	Oak mocca	II
116	Oak anthracite	II
117	Natural oak	II
122	Light brown ash	II
113	Cherrywood gold	III
118	Walnut	III
120	White lacquer	IV

Please be sure to state the **model no. of the formed wooden seat version** in your order!



**D 5-1**

**Bowl-shaped chair**

Substructure versions: aluminium-coloured, powder coated / high-gloss/matt/black chrome

Total height: 77 cm  
 Total width: 56 cm  
 Total depth: 59 cm  
 Seat height: 48 cm  
 Seat width: 47 cm  
 Seat depth: 46.5 cm  
 Fabric req.: 1.1 m  
 Leather req.: 1.6 m<sup>2</sup>

	Structured fabric (63..) Chenille »floral« (69..) Cotton-wool-Jacquard (75..) Woven Jacquard (82..) Woven Jacquard glossy (83..)	Velour CS (62..) Structured fabric »pure« (77..)	Leather (51..) »Dinamica« (68..) Wool fabric (80..)	Saddle leather (65..) Leather »metallic« (79..)
Substructure version: aluminium-coloured, powder coated				
<b>Price gr.</b>	<b>D 511....</b>	<b>D 511....</b>	<b>D 511....</b>	<b>D 511....</b>
I	-	-	-	-
II	-	-	-	-
III	-	-	-	-
IV	-	-	-	-
Substructure version: High-gloss chrome				
<b>Price gr.</b>	<b>D 512....</b>	<b>D 512....</b>	<b>D 512....</b>	<b>D 512....</b>
I	-	-	-	-
II	-	-	-	-
III	-	-	-	-
IV	-	-	-	-
Substructure version: Matt chrome				
<b>Price gr.</b>	<b>D 513....</b>	<b>D 513....</b>	<b>D 513....</b>	<b>D 513....</b>
I	-	-	-	-
II	-	-	-	-
III	-	-	-	-
IV	-	-	-	-
Substructure version: Black chrome				
<b>Price gr.</b>	<b>D 514....</b>	<b>D 514....</b>	<b>D 514....</b>	<b>D 514....</b>
I	-	-	-	-
II	-	-	-	-
III	-	-	-	-
IV	-	-	-	-



**D 5-2**

**Bowl-shaped chair**

Substructure versions: aluminium-coloured, powder coated / high-gloss/matt/black chrome

Total height: 77 cm  
 Total width: 56 cm  
 Total depth: 59 cm  
 Seat height: 48 cm  
 Seat width: 47 cm  
 Seat depth: 46.5 cm  
 Fabric req.: 1.1 m  
 Leather req.: 1.6 m<sup>2</sup>

Substructure version: aluminium-coloured, powder coated				
<b>Price gr.</b>	<b>D 521....</b>	<b>D 521....</b>	<b>D 521....</b>	<b>D 521....</b>
I	-	-	-	-
II	-	-	-	-
III	-	-	-	-
IV	-	-	-	-
Substructure version: High-gloss chrome				
<b>Price gr.</b>	<b>D 522....</b>	<b>D 522....</b>	<b>D 522....</b>	<b>D 522....</b>
I	-	-	-	-
II	-	-	-	-
III	-	-	-	-
IV	-	-	-	-
Substructure version: Matt chrome				
<b>Price gr.</b>	<b>D 523....</b>	<b>D 523....</b>	<b>D 523....</b>	<b>D 523....</b>
I	-	-	-	-
II	-	-	-	-
III	-	-	-	-
IV	-	-	-	-
Substructure version: Black chrome				
<b>Price gr.</b>	<b>D 524....</b>	<b>D 524....</b>	<b>D 524....</b>	<b>D 524....</b>
I	-	-	-	-
II	-	-	-	-
III	-	-	-	-
IV	-	-	-	-

## D 7 **The curving one**

The movement of a wave – soft curves in the armrest, in the back section. This model not only appeals by way of its form and its high-quality finish – all-round "Keder" seams, extraordinarily comfortable seats and homely fabrics – all help create a feeling of well-being. The extra comfort afforded by the seats is pleasantly underlined by a slight rocking function in the backrest.

### Product spectrum

- The model comes without armrests – perfect for combining, with a cosy upholstered armrest and with a curving metal armrest that is provided with a lightly upholstered cover (leather, Dinamica, velour) in a matching colour shade.
- 2 backrest heights: 83 cm and 101 cm
- Metal substructure: aluminium-coloured, powder-coated, high-gloss chrome, matt chrome or black chrome

### Product features

- Seat and rear bowl of formed wood, connected with one another by a flexible metal bracket
- Seat upholstery: formed upholstery with a volume weight of 40 kg/m<sup>3</sup> and a form retention value of 4.5 kPa
- Backrest upholstery: foam material with integrated lower spine support, volume weight of 40 kg/m<sup>3</sup>, form retention: 4.5 kPa
- Cover fabric with quilted Polyester fleece sublayer
- Plastic and felt gliders are included (for hard and soft floors)



### Metal surfaces

- Aluminium-coloured, powder coated
- High-gloss chrome
- Matt chrome
- Black chrome

### Cover materials







- High-grade leather in contemporary colours
- Microfibre "Dinamica" in homely colours
- Modern textile cover fabrics, easy-to-care for with high-quality protection against soiling
- Customer's fabrics possible (price group = best fabric price group)



### Surface coating of metal armrests

For leather: in the corresponding leather colour  
 For Dinamica: in the corresponding Dinamica colour  
 For velour: in the corresponding velour colour  
 For structured fabric »pure«: in the corresponding structured fabric colour  
 For textile cover fabrics:

in 5105 (black leather) for	6302	6304	6305	6901	8001	8004
in 5109 (cream leather) for	7501	8002				
in 5101 (beige leather) for	7502	8201				
in 5104 (anthracite leather) for	7504	7505	8204	8206	8207	8303
in 5110 (mocca leather) for	6301	6303	7503	8203	8205	
in 5114 (grey-brown leather) for	8003					
in 5122 (sand leather) for	8301					
in 5123 (brown-black leather) for	8302					

		Structured fabric (63..) Chenille »floral« (69..) Cotton-wool-Jacquard (75..) Woven Jacquard (82..) Woven Jacquard glossy (83..)	Velour CS (62..) Structured fabric »pure« (77..)	Leather (51..) »Dinamica« (68..) Wool fabric (80..)	Saddle leather (65..) Leather »metallic« (79..)
 <p><b>D 7-1</b> <b>Upholstered chair with low backrest</b> Substructure versions: aluminium-coloured, powder coated / high-gloss/matt/black chrome Total height: 88 cm Total width: 53 cm Total depth: 60 cm Seat height: 50 cm Seat width: 53:47 cm Seat depth: 50 cm Fabric req.: 1.7 m<sup>2</sup> Leather req.: 1.9 m<sup>2</sup></p>	Substructure version: aluminium-coloured, powder coated	D 711....	D 711....	D 711....	D 711....
	Substructure version: High-gloss chrome	D 712....	D 712....	D 712....	D 712....
	Substructure version: Matt chrome	D 713....	D 713....	D 713....	D 713....
	Substructure version: Black chrome	D 714....	D 714....	D 714....	D 714....
 <p><b>D 7-2</b> <b>Upholstered chair with low backrest and with upholstered armrests</b> Substructure versions: aluminium-coloured, powder coated / high-gloss/matt/black chrome Total height: 88 cm Total width: 59 cm Total depth: 60 cm Seat height: 50 cm Seat width: 53:47 cm Seat depth: 50 cm Armrest height: 66.5 cm Fabric req.: 2.3 m<sup>2</sup> Leather req.: 2.7 m<sup>2</sup></p>	Substructure version: aluminium-coloured, powder coated	D 721....	D 721....	D 721....	D 721....
	Substructure version: High-gloss chrome	D 722....	D 722....	D 722....	D 722....
	Substructure version: Matt chrome	D 723....	D 723....	D 723....	D 723....
	Substructure version: Black chrome	D 724....	D 724....	D 724....	D 724....
 <p><b>D 7-3</b> <b>Upholstered chair with low backrest and with metal armrests and upholstery</b> Substructure versions: aluminium-coloured, powder coated / high-gloss/matt/black chrome Total height: 88 cm Total width: 54 cm Total depth: 60 cm Seat height: 50 cm Seat width: 53:47 cm Seat depth: 50 cm Armrest height: 66.5 cm Fabric req.: 1.9 m<sup>2</sup> Leather req.: 2.5 m<sup>2</sup></p>	Substructure version: aluminium-coloured, powder coated	D 731....	D 731....	D 731....	D 731....
	Substructure version: High-gloss chrome	D 732....	D 732....	D 732....	D 732....
	Substructure version: Matt chrome	D 733....	D 733....	D 733....	D 733....
	Substructure version: Black chrome	D 734....	D 734....	D 734....	D 734....
 <p><b>D 7-4</b> <b>Upholstered chair with high backrest</b> Substructure versions: aluminium-coloured, powder coated / high-gloss/matt/black chrome Total height: 101 cm Total width: 53 cm Total depth: 66 cm Seat height: 50 cm Seat width: 53:47 cm Seat depth: 50 cm Fabric req.: 1.9 m<sup>2</sup> Leather req.: 2.7 m<sup>2</sup></p>	Substructure version: aluminium-coloured, powder coated	D 741....	D 741....	D 741....	D 741....
	Substructure version: High-gloss chrome	D 742....	D 742....	D 742....	D 742....
	Substructure version: Matt chrome	D 743....	D 743....	D 743....	D 743....
	Substructure version: Black chrome	D 744....	D 744....	D 744....	D 744....
 <p><b>D 7-5</b> <b>Upholstered chair with high backrest and with upholstered armrests</b> Substructure versions: aluminium-coloured, powder coated / high-gloss/matt/black chrome Total height: 101 cm Total width: 59 cm Total depth: 66 cm Seat height: 50 cm Seat width: 53:47 cm Seat depth: 50 cm Armrest height: 66.5 cm Fabric req.: 2.4 m<sup>2</sup> Leather req.: 3.5 m<sup>2</sup></p>	Substructure version: aluminium-coloured, powder coated	D 751....	D 751....	D 751....	D 751....
	Substructure version: High-gloss chrome	D 752....	D 752....	D 752....	D 752....
	Substructure version: Matt chrome	D 753....	D 753....	D 753....	D 753....
	Substructure version: Black chrome	D 754....	D 754....	D 754....	D 754....
 <p><b>D 7-6</b> <b>Upholstered chair with high backrest and with metal armrests and upholstery</b> Substructure versions: aluminium-coloured, powder coated / high-gloss/matt/black chrome Total height: 101 cm Total width: 54 cm Total depth: 66 cm Seat height: 50 cm Seat width: 53:47 cm Seat depth: 50 cm Armrest height: 66.5 cm Fabric req.: 2.0 m<sup>2</sup> Leather req.: 2.8 m<sup>2</sup></p>	Substructure version: aluminium-coloured, powder coated	D 761....	D 761....	D 761....	D 761....
	Substructure version: High-gloss chrome	D 762....	D 762....	D 762....	D 762....
	Substructure version: Matt chrome	D 763....	D 763....	D 763....	D 763....
	Substructure version: Black chrome	D 764....	D 764....	D 764....	D 764....

## D 11 Solid wooden chair – the original one

A soft curve in the backrest, an armrests that carries on this curve into the chair leg. The wooden frame determines the look of the backrest, which gives the chair a much less flat appearance than is the case in many other chair models. The light, slim seat and rear upholstery that is easy on the eye enhances the extraordinarily comfortable feeling the chair gives by virtue of its ergonomically shaped seat and rear surfaces – matching the contours of the unit itself. The contemporary leather colours create some interesting touches for the solid wood; the frame's form is particularly striking when viewed from the rear.

### Product spectrum

- 2 backrest heights: 80.5 and 90.5 cm
- The chair is available with or without armrests
- The cover material can be chosen from 3 types of leather

### Product features

- The backrest surface is in a solid wooden frame which continues down into the chair legs
- The armrests and front chair legs are connected by a mitre joint, very fine dovetails stabilise the connection and underline the craftsmanlike finish
- The upholstery looks slim and light as it is hardly visible. The comfort features of the unit are hidden by the seat frame, the comfortable upholstery is accommodated there
- Seat upholstery: a combination of a surface with belts and a layer of upholstery in RG 75130 "sandwich" style
- Rear upholstery: foam with a volume weight of 3555, 10 mm thick
- Plastic and felt gliders are included (for hard and soft floors)



### Cover materials

- 3 different types of leather
- Customer leather possible (same price as leather 51..)

### List of versions Substructure

Model no.	Version	Price group
110	Solid beech	I
115	Solid oak mocca	II
117	Solid natural oak	II
113	Solid Cherrywood gold	III
118	Solid walnut	IV

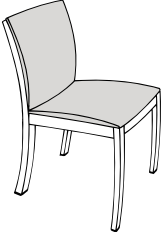
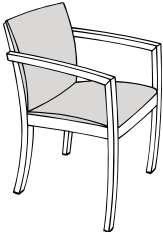
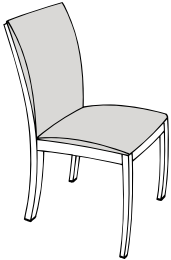
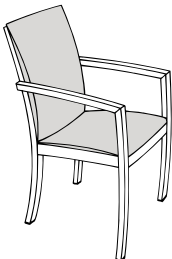

Please be sure to state the **model no. of the substructure wood version** in your order!

		Leather (51..)	Saddle leather (65..) Leather »metallic« (79..)
 <p><b>D 11-1</b> Solid wooden chair with low backrest and with seat upholstery</p> <p>Total height: 80.5 cm Total width: 48 cm Total depth: 54.5 cm Seat height: 45 cm Seat width: 48 cm Seat depth: 42.5 cm Leather req.: 1.2 m<sup>2</sup></p>	<p>Price gr. I II III IV</p>	<p>D 111.... - - - -</p>	<p>D 111.... - - - -</p>
 <p><b>D 11-2</b> Solid wooden chair with low backrest and with wooden armrests and seat upholstery</p> <p>Total height: 80.5 cm Total width: 55 cm Total depth: 54.5 cm Seat height: 45 cm Seat width: 48 cm Seat depth: 42.5 cm Armrest height: max. 66.0 cm Leather req.: 1.2 m<sup>2</sup></p>	<p>Price gr. I II III IV</p>	<p>D 112.... - - - -</p>	<p>D 112.... - - - -</p>
 <p><b>D 11-3</b> Solid wooden chair with high backrest and with seat upholstery</p> <p>Total height: 90.5 cm Total width: 48 cm Total depth: 58 cm Seat height: 45 cm Seat width: 48 cm Seat depth: 42.5 cm Leather req.: 1.6 m<sup>2</sup></p>	<p>Price gr. I II III IV</p>	<p>D 113.... - - - -</p>	<p>D 113.... - - - -</p>
 <p><b>D 11-4</b> Solid wooden chair with high backrest and with wooden armrests and seat upholstery</p> <p>Total height: 90.5 cm Total width: 55 cm Total depth: 58 cm Seat height: 45 cm Seat width: 48 cm Seat depth: 42.5 cm Armrest height: max. 66.0 cm Leather req.: 1.6 m<sup>2</sup></p>	<p>Price gr. I II III IV</p>	<p>D 114.... - - - -</p>	<p>D 114.... - - - -</p>

## D 12 Upholstered armchair – the comfortable one

---

Elegant and attractive upholstered armchair which is very appealing by way of its clear, practical form. Based on simple, geometric forms, it achieves a degree of homely elegance and simplicity. This is underlined by the pleasant upholstery which allows the user to sink into the seat easily whilst still affording the necessary support. Detailed workmanship and some intricate design details make it a unit that will last an eternity.

### Product spectrum

- The model is available with an 81 cm high backrest and a full-length armrest

### Product features

- Seat and rear surface with a woven belt spring base
- Upholstery made of PUR foam with a volume weight of 4045
- Cover under quilted with Polyester fleece
- Plastic and felt gliders are included (for hard and soft floors)



### Cover materials

- High-grade leather in contemporary colours
- Microfibre “Dinamica” in homely colours
- Modern textile cover fabrics, easy-to-care for with high-quality protection against soiling
- Customer fabric possible (price group = best fabric price group)

	Structured fabric (63..) Chenille »floral« (69..) Cotton-wool-Jacquard (75..) Woven Jacquard (82..) Woven Jacquard glossy (83..)	Velour CS (62..) Structured fabric »pure« (77..)	Leather (51..) »Dinamica« (68..) Wool fabric (80..)	Saddle leather (65..) Leather »metallic« (79..)
<div data-bbox="98 1093 255 1294" data-label="Image"> </div> <div data-bbox="391 1003 517 1052" data-label="Section-Header"> <h3>D 12-1</h3> </div> <div data-bbox="391 1059 587 1090" data-label="Section-Header"> <h4>Upholstered armchair</h4> </div> <div data-bbox="391 1106 715 1296" data-label="Text"> <p>                         Total height: 81 cm                          Total width: 59 cm                          Total depth: 59 cm                          Seat height: 48.5 cm                          Seat width: 46.43 cm                          Seat depth: 46 cm                          Armrest height: max. 66.5 cm                          Fabric req.: 2.6 m                          Leather req.: 4.4 m<sup>2</sup> </p> </div>	<p>D 121....</p> <p>-</p>	<p>D 121....</p> <p>-</p>	<p>D 121....</p> <p>-</p>	<p>D 121....</p> <p>-</p>

## D 13 The variable one

Clarity and straightforwardness hallmark the design of the seat bowl – the essential basis for longevity and also the right basis for being able to present itself in a different look together with various leg types. This harmony between the seat and the base is well-balanced and harmonious in all three cases: the proportions are correct, the design is clear and logical. The model D 13 provides you with a number of ways of putting together “your” chair.

### Product spectrum

- Individual combination of seat bowl:
  - 2 back heights: low and high
  - 2 seat widths: standard seat width 47 cm, comfort seat width 52 cm
  - 3 seat comfort levels: loose cushions in firm - medium - soft
- Individual choice of legs with 3 types of bases:
  - Flat tubular steel free-swinging base: with optional armrest of the same material
  - Square tubular substructure: with optional upholstered armrests
  - Plate-shaped base: with optional metal armrests and/or automatic resetting device
- 3 metal surfaces: matt chrome, high-gloss chrome and black chrome
- Plastic and felt gliders are included (for hard and soft floors); exception: D 13 with revolving plate-shaped base only with a felt disk



### Product features

- Seat bowl:
  - base construction: solid metal substructure, seat frame of metal with steel shaft springs
  - backrest function: use of spring steel – yields to pressure and adapts to the body
- Seat comfort levels of loose cushions (are fixed to the seat frame with a Velcro band):
  - A - Firm:** spring core cushions  
Intensive seat support; the spring core cushion (cylinder pocket springs, wire strength 1.6 cm) is embedded in a frame of polyether foam, RG 4070. Covered with a polyether foam material.
  - B - Medium:** cold foam cushion  
Comfortable seat support; polyether foam RG 5040 HR
  - C - Soft:** spring flex cushion  
Gentle seat support: mixture of springs and foam sticks cut in small lengths (Tangaflex: form retention level 4.6 kpa). The springs, proportion of 35%, have a lubricating and gliding function in the cushion, the Tangaflex padding gives the cushion its shape.
- Substructures:
  - Flat tubular steel free-swinging substructure: of solid flat steel, 30x15 mm
  - Square tubular substructure: of square tubular steel, 20x20x2 mm
  - Plate-shaped base (revolving): of solid steel plate, Ø 4.5 cm, 8 mm thick



**Metal surfaces**

- High-gloss chrome
- Matt chrome
- Black chrome

**Cover materials**

- High-grade leather in contemporary colours
- Microfibre "Dinamica" in homely colours
- Modern textile cover fabrics, easy-to-care for with high-quality protection against soiling
- Customer's fabrics possible (price group = best fabric price group)

**Surface coating of metal armrests**

For leather: in the corresponding leather colour  
 For Dinamica: in the corresponding Dinamica colour  
 For velour: in the corresponding velour colour  
 For structured fabric »pure«: in the corresponding structured fabric colour  
 For textile cover fabrics:

in 5105 (black leather) for	6302	6304	6305	6901	8001	8004
in 5109 (cream leather) for	7501	8002				
in 5101 (beige leather) for	7502	8201				
in 5104 (anthracite leather) for	7504	7505	8204	8206	8207	8303
in 5110 (mocca leather) for	6301	6303	7503	8203	8205	
in 5114 (grey-brown leather) for	8003					
in 5122 (sand leather) for	8301					
in 5123 (brown-black leather) for	8302					

**Example of order**

The D13 upholstered chair is a model which provides you with an enormous amount of choice. Besides the many different cover fabrics, this chair is available with or without armrests, with low or high backrests, as well as with three different substructures. With the D 13 you have even more opportunities of fitting out your chair individually: the chair is available in two widths (47 and 52 cm) and with different cushions (with spring core, spring flex or cold foam padding). **Both seat widths and all three types of cushion padding are at the same price.**

Please be sure to state **the seat cushion padding and the seat width** in your order. Add on digits to the type numbers of the required chair:

for the padding of the cushion add an **A** - Firm: spring core  
**B** - Medium: cold foam  
 or **C** - Soft: spring flex



After the letter please then state the required seat width:  
**4** (for seat width of 47 cm)  
 or **5** (for seat width of 52 cm)



**Example:**

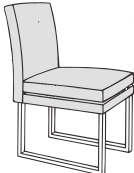
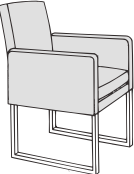
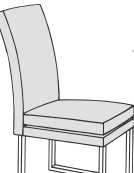
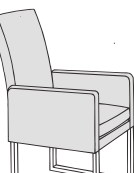

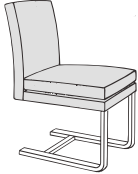
The order number of the "simplest" model of D13 (without armrests, with low backrest, square tubular substructure, high-gloss chrome) with cushion padding of spring flex in comfort width 52 cm looks like this:

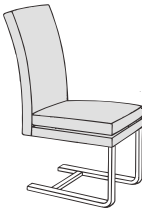
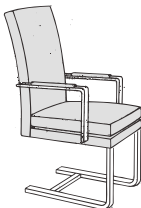
**D13111C5**

<b>D 13</b> Upholstered chair with square profiled tubular substructure		Structured fabric (63..) Chenille »floral« (69..) Cotton-wool-Jacquard (75..) Woven Jacquard (82..) Woven Jacquard glossy (83..)	Velour CS (62..) Structured fabric »pure« (77..)	Leather (51..) »Dinamica« (68..) Wool fabric (80..)	Saddle leather (65..) Leather »metallic« (79..)
 <p><b>D 13-11</b> Upholstered chair with low backrest</p> <p>Substructure versions: high-gloss/matt/black chrome</p> <p>Total height: 85 cm Total width: see seat width Total depth: 55 cm Seat height: 49 cm Seat width: 47 or 52 cm Seat depth: 45.5 cm Fabric req.: 1.3 m Leather req.: 2.3 m<sup>2</sup></p>	Substructure version: High-gloss chrome	D 13111.... -	D 13111.... -	D 13111.... -	D 13111.... -
	Substructure version: Matt chrome	D 13112.... -	D 13112.... -	D 13112.... -	D 13112.... -
	Substructure version: Black chrome	D 13113.... -	D 13113.... -	D 13113.... -	D 13113.... -
 <p><b>D 13-21</b> Upholstered chair with low backrest and with upholstered armrests</p> <p>Substructure versions: high-gloss/matt/black chrome</p> <p>Total height: 85 cm Total width: see seat width + 5 cm Total depth: 55 cm Seat height: 49 cm Seat width: 47 or 52 cm Seat depth: 45.5 cm Armrest height: 65 cm Fabric req.: 2.5 m Leather req.: 3.8 m<sup>2</sup></p>	Substructure version: High-gloss chrome	D 13211.... -	D 13211.... -	D 13211.... -	D 13211.... -
	Substructure version: Matt chrome	D 13212.... -	D 13212.... -	D 13212.... -	D 13212.... -
	Substructure version: Black chrome	D 13213.... -	D 13213.... -	D 13213.... -	D 13213.... -
 <p><b>D 13-31</b> Upholstered chair with high backrest</p> <p>Substructure versions: high-gloss/matt/black chrome</p> <p>Total height: 94.5 cm Total width: see seat width Total depth: 55 cm Seat height: 49 cm Seat width: 47 or 52 cm Seat depth: 45.5 cm Fabric req.: 1.4 m Leather req.: 2.4 m<sup>2</sup></p>	Substructure version: High-gloss chrome	D 13311.... -	D 13311.... -	D 13311.... -	D 13311.... -
	Substructure version: Matt chrome	D 13312.... -	D 13312.... -	D 13312.... -	D 13312.... -
	Substructure version: Black chrome	D 13313.... -	D 13313.... -	D 13313.... -	D 13313.... -
 <p><b>D 13-41</b> Upholstered chair with high backrest and with upholstered armrests</p> <p>Substructure versions: high-gloss/matt/black chrome</p> <p>Total height: 94.5 cm Total width: see seat width + 5 cm Total depth: 55 cm Seat height: 49 cm Seat width: 47 or 52 cm Seat depth: 45.5 cm Armrest height: 65 cm Fabric req.: 2.6 m Leather req.: 3.9 m<sup>2</sup></p>	Substructure version: High-gloss chrome	D 13411.... -	D 13411.... -	D 13411.... -	D 13411.... -
	Substructure version: Matt chrome	D 13412.... -	D 13412.... -	D 13412.... -	D 13412.... -
	Substructure version: Black chrome	D 13413.... -	D 13413.... -	D 13413.... -	D 13413.... -

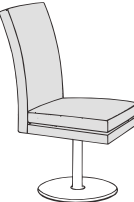
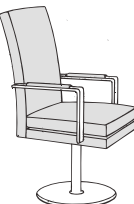
<b>D 13 Upholstered chair with flat steel free swinging substructure</b>		Structured fabric (63..) Chenille »floral« (69..) Cotton-wool-Jacquard (75..) Woven Jacquard (82..) Woven Jacquard glossy (83..)	Velour CS (62..) Structured fabric »pure« (77..)	Leather (51..) »Dinamica« (68..) Wool fabric (80..)	Saddle leather (65..) Leather »metallic« (79..)
 <p><b>D 13-12</b> Upholstered chair with low backrest</p> <p>Substructure versions: high-gloss/matt/black chrome</p> <p>Total height: 87 cm Total width: see seat width Total depth: 55 cm Seat height: 50 cm Seat width: 47 or 52 cm Seat depth: 45.5 cm Fabric req.: 1.3 m Leather req.: 2.3 m<sup>2</sup></p>	Substructure version: High-gloss chrome	D 13121....	D 13121....	D 13121....	D 13121....
	Substructure version: Matt chrome	D 13122....	D 13122....	D 13122....	D 13122....
	Substructure version: Black chrome	D 13123....	D 13123....	D 13123....	D 13123....
 <p><b>D 13-22</b> Upholstered chair with low backrest and with metal armrests</p> <p>Substructure versions: high-gloss/matt/black chrome</p> <p>Total height: 87 cm Total width: see seat width + 5 cm Total depth: 55 cm Seat height: 50 cm Seat width: 47 or 52 cm Seat depth: 45.5 cm Armrest height: 64.5 cm Fabric req.: 1.4 m Leather req.: 2.5 m<sup>2</sup></p>	Substructure version: High-gloss chrome	D 13221....	D 13221....	D 13221....	D 13221....
	Substructure version: Matt chrome	D 13222....	D 13222....	D 13222....	D 13222....
	Substructure version: Black chrome	D 13223....	D 13223....	D 13223....	D 13223....
 <p><b>D 13-32</b> Upholstered chair with high backrest</p> <p>Substructure versions: high-gloss/matt/black chrome</p> <p>Total height: 96 cm Total width: see seat width Total depth: 58 cm Seat height: 50 cm Seat width: 47 or 52 cm Seat depth: 45.5 cm Fabric req.: 1.4 m Leather req.: 2.4 m<sup>2</sup></p>	Substructure version: High-gloss chrome	D 13321....	D 13321....	D 13321....	D 13321....
	Substructure version: Matt chrome	D 13322....	D 13322....	D 13322....	D 13322....
	Substructure version: Black chrome	D 13323....	D 13323....	D 13323....	D 13323....
 <p><b>D 13-42</b> Upholstered chair with high backrest and with metal armrests</p> <p>Substructure versions: high-gloss/matt/black chrome</p> <p>Total height: 96 cm Total width: see seat width + 5 cm Total depth: 58 cm Seat height: 50 cm Seat width: 47 or 52 cm Seat depth: 45.5 cm Armrest height: 64.5 cm Fabric req.: 1.5 m Leather req.: 2.6 m<sup>2</sup></p>	Substructure version: High-gloss chrome	D 13421....	D 13421....	D 13421....	D 13421....
	Substructure version: Matt chrome	D 13422....	D 13422....	D 13422....	D 13422....
	Substructure version: Black chrome	D 13423....	D 13423....	D 13423....	D 13423....

<b>D 13 Upholstered chair with revolving plate-shaped base</b>			Structured fabric (63..) Chenille »floral« (69.) Cotton-wool-Jacquard (75..) Woven Jacquard (82..) Woven Jacquard glossy (83..)	Velour CS (62..) Structured fabric »pure« (77..)	Leather (51..) »Dinamica« (68..) Wool fabric (80..)	Saddle leather (65..) Leather »metallic« (79..)
 <p><b>D 13-13</b>                      Upholstered chair with low backrest</p> <p>Substructure versions:                      high-gloss/matt/black chrome</p> <p>Total height: 85 cm                      Total width: see seat width                      Total depth: 55 cm                      Seat height: 49 cm                      Seat width: 47 or 52 cm                      Seat depth: 45.5 cm                      Fabric req.: 1.3 m<sup>2</sup>                      Leather req.: 2.3 m<sup>2</sup></p>	Substructure version: High-gloss chrome	D 13131.... -	D 13131.... -	D 13131.... -	D 13131.... -	
	Substructure version: Matt chrome	D 13132.... -	D 13132.... -	D 13132.... -	D 13132.... -	
	Substructure version: Black chrome	D 13133.... -	D 13133.... -	D 13133.... -	D 13133.... -	
 <p><b>D 13-23</b>                      Upholstered chair with low backrest and with metal armrests</p> <p>Substructure versions:                      high-gloss/matt/black chrome</p> <p>Total height: 85 cm                      Total width: see seat width + 5 cm                      Total depth: 55 cm                      Seat height: 49 cm                      Seat width: 47 or 52 cm                      Seat depth: 45.5 cm                      Armrest height: 64 cm                      Fabric req.: 1.4 m<sup>2</sup>                      Leather req.: 2.5 m<sup>2</sup></p>	Substructure version: High-gloss chrome	D 13231.... -	D 13231.... -	D 13231.... -	D 13231.... -	
	Substructure version: Matt chrome	D 13232.... -	D 13232.... -	D 13232.... -	D 13232.... -	
	Substructure version: Black chrome	D 13233.... -	D 13233.... -	D 13233.... -	D 13233.... -	
 <p><b>D 13-33</b>                      Upholstered chair with high backrest</p> <p>Substructure versions:                      high-gloss/matt/black chrome</p> <p>Total height: 94.5 cm                      Total width: see seat width                      Total depth: 55 cm                      Seat height: 49 cm                      Seat width: 47 or 52 cm                      Seat depth: 45.5 cm                      Fabric req.: 1.4 m<sup>2</sup>                      Leather req.: 2.4 m<sup>2</sup></p>	Substructure version: High-gloss chrome	D 13331.... -	D 13331.... -	D 13331.... -	D 13331.... -	
	Substructure version: Matt chrome	D 13332.... -	D 13332.... -	D 13332.... -	D 13332.... -	
	Substructure version: Black chrome	D 13333.... -	D 13333.... -	D 13333.... -	D 13333.... -	
 <p><b>D 13-43</b>                      Upholstered chair with high backrest and with metal armrests</p> <p>Substructure versions:                      high-gloss/matt/black chrome</p> <p>Total height: 94.5 cm                      Total width: see seat width + 5 cm                      Total depth: 55 cm                      Seat height: 49 cm                      Seat width: 47 or 52 cm                      Seat depth: 45.5 cm                      Armrest height: 64 cm                      Fabric req.: 1.5 m<sup>2</sup>                      Leather req.: 2.6 m<sup>2</sup></p>	Substructure version: High-gloss chrome	D 13431.... -	D 13431.... -	D 13431.... -	D 13431.... -	
	Substructure version: Matt chrome	D 13432.... -	D 13432.... -	D 13432.... -	D 13432.... -	
	Substructure version: Black chrome	D 13433.... -	D 13433.... -	D 13433.... -	D 13433.... -	

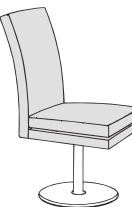
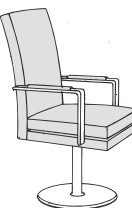
<p><b>D 13</b> Upholstered chair with revolving plate-shaped base and automatic resetting device</p>		<p>Structured fabric (63..) Chenille »floral« (69..) Cotton-wool-Jacquard (75..) Woven Jacquard (82..) Woven Jacquard glossy (83..)</p>	<p>Velour CS (62..) Structured fabric »pure« (77..)</p>	<p>Leather (51..) »Dinamica« (68..) Wool fabric (80..)</p>	<p>Saddle leather (65..) Leather »metallic« (79..)</p>
 <p><b>D 13-14</b> Upholstered chair with low backrest</p> <p>Substructure versions: high-gloss/matt/black chrome</p> <p>Total height: 85 cm Total width: see seat width Total depth: 55 cm Seat height: 49 cm Seat width: 47 or 52 cm Seat depth: 45.5 cm Fabric req.: 1.3 m Leather req.: 2.3 m<sup>2</sup></p> <p>with automatic resetting device</p>	<p>Substructure version: High-gloss chrome</p>	<p>D 13141....</p>	<p>D 13141....</p>	<p>D 13141....</p>	<p>D 13141....</p>
	<p>Substructure version: Matt chrome</p>	<p>D 13142....</p>	<p>D 13142....</p>	<p>D 13142....</p>	<p>D 13142....</p>
	<p>Substructure version: Black chrome</p>	<p>D 13143....</p>	<p>D 13143....</p>	<p>D 13143....</p>	<p>D 13143....</p>
 <p><b>D 13-24</b> Upholstered chair with low backrest and with metal armrests</p> <p>Substructure versions: high-gloss/matt/black chrome</p> <p>Total height: 85 cm Total width: see seat width + 5 cm Total depth: 55 cm Seat height: 49 cm Seat width: 47 or 52 cm Seat depth: 45.5 cm Armrest height: 64 cm Fabric req.: 1.4 m Leather req.: 2.5 m<sup>2</sup></p> <p>with automatic resetting device</p>	<p>Substructure version: High-gloss chrome</p>	<p>D 13241....</p>	<p>D 13241....</p>	<p>D 13241....</p>	<p>D 13241....</p>
	<p>Substructure version: Matt chrome</p>	<p>D 13242....</p>	<p>D 13242....</p>	<p>D 13242....</p>	<p>D 13242....</p>
	<p>Substructure version: Black chrome</p>	<p>D 13243....</p>	<p>D 13243....</p>	<p>D 13243....</p>	<p>D 13243....</p>
 <p><b>D 13-34</b> Upholstered chair with high backrest</p> <p>Substructure versions: high-gloss/matt/black chrome</p> <p>Total height: 94.5 cm Total width: see seat width Total depth: 55 cm Seat height: 49 cm Seat width: 47 or 52 cm Seat depth: 45.5 cm Fabric req.: 1.4 m Leather req.: 2.4 m<sup>2</sup></p> <p>with automatic resetting device</p>	<p>Substructure version: High-gloss chrome</p>	<p>D 13341....</p>	<p>D 13341....</p>	<p>D 13341....</p>	<p>D 13341....</p>
	<p>Substructure version: Matt chrome</p>	<p>D 13342....</p>	<p>D 13342....</p>	<p>D 13342....</p>	<p>D 13342....</p>
	<p>Substructure version: Black chrome</p>	<p>D 13343....</p>	<p>D 13343....</p>	<p>D 13343....</p>	<p>D 13343....</p>
 <p><b>D 13-44</b> Upholstered chair with high backrest and with metal armrests</p> <p>Substructure versions: high-gloss/matt/black chrome</p> <p>Total height: 94.5 cm Total width: see seat width + 5 cm Total depth: 55 cm Seat height: 49 cm Seat width: 47 or 52 cm Seat depth: 45.5 cm Armrest height: 64 cm Fabric req.: 1.5 m Leather req.: 2.6 m<sup>2</sup></p> <p>with automatic resetting device</p>	<p>Substructure version: High-gloss chrome</p>	<p>D 13441....</p>	<p>D 13441....</p>	<p>D 13441....</p>	<p>D 13441....</p>
	<p>Substructure version: Matt chrome</p>	<p>D 13442....</p>	<p>D 13442....</p>	<p>D 13442....</p>	<p>D 13442....</p>
	<p>Substructure version: Black chrome</p>	<p>D 13443....</p>	<p>D 13443....</p>	<p>D 13443....</p>	<p>D 13443....</p>

# D 15-Bench

With this bench system it is our aim to ensure that it is possible to combine these units with all the chairs that are available in our assortment. This is why we have kept the design form simple and straightforward - resulting in a modern and elegant appearance.

Thick upholstery in the seat and in the backrest is extremely comfortable in use and will soon make this seat your "favourite place". The interplay between the upholstery and the simple substructure can be used to create a very harmonious tone in tone look or to create more contrasting versions

## Product spectrum

- **Solitary benches without backrest** in 4 widths: 160 cm, 180 cm, 200 cm, 220 cm
- **Solitary benches with backrest** in 4 widths: 160 cm, 180 cm, 200 cm, 220 cm
- **Solitary benches with a side shelf of 40 cm** in 4 widths: 200 cm, 220 cm, 240 cm, 260 cm (side shelf optionally left or right)
- **Bench with integrated corner** in 2 widths: 160 cm, 200 cm (in left-hand and right-hand versions)
- **Corner bench:** created by using a solitary bench and a bench with an integrated corner!



## Product features

- **Upholstery construction/height adjustment:** height adjustment is particularly important when planning a corner bench. This is why there is a height adjustable leg in the substructure which allows adjustments up to 15 mm.
- **Positioning anywhere in room:** it is also possible to position the units anywhere in the room because of the high-grade finish of the backrest and the cover material and the perfect workmanship!

## Cover materials

- High-grade leather in contemporary colours
- Microfibre "Dinamica" in homely colours
- Modern textile cover fabrics, easy-to-care for with high-quality protection against soiling
- Customer's fabrics possible (price group = best fabric price group)

## List of versions Substructure

Model no.	Version	Price group
121	Structured beech	I
115	Oak mocca	II
<b>NEW</b> 122	Light brown ash	II
118	Walnut	III

Please be sure to state the **model no. of the substructure wood version** in your order!

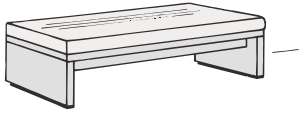
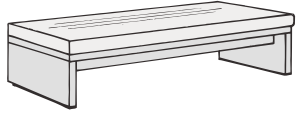
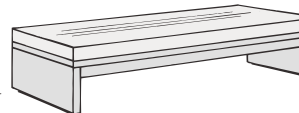
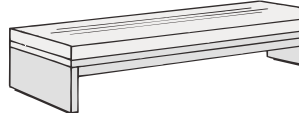
		Structured fabric (63..) Chenille »floral« (69..) Cotton-wool-Jacquard (75..) Woven Jacquard (82..) Woven Jacquard glossy (83..)	Velour CS (62..) Structured fabric »pure« (77..)	Leather (51..) »Dinamica« (68..) Wool fabric (80..)	Saddle leather (65..) Leather »metallic« (79..)
 <p><b>D 15-01</b> <b>Bench</b> <b>160 cm wide</b></p> <p>Total height: 47 cm Total width: 160 cm Total depth: 51 cm Seat height: 47 cm Seat width: 160 cm Seat depth: 51 cm Fabric req.: 1.8 m Leather req.: 2.6 m<sup>2</sup></p>					
	<p><b>Price gr.</b> I II III</p>	<p>D 1501....</p> <p>- - -</p>	<p>D 1501....</p> <p>- - -</p>	<p>D 1501....</p> <p>- - -</p>	<p>D 1501....</p> <p>- - -</p>
 <p><b>D 15-02</b> <b>Bench</b> <b>180 cm wide</b></p> <p>Total height: 47 cm Total width: 180 cm Total depth: 51 cm Seat height: 47 cm Seat width: 180 cm Seat depth: 51 cm Fabric req.: 2.0 m Leather req.: 2.8 m<sup>2</sup></p>					
	<p><b>Price gr.</b> I II III</p>	<p>D 1502....</p> <p>- - -</p>	<p>D 1502....</p> <p>- - -</p>	<p>D 1502....</p> <p>- - -</p>	<p>D 1502....</p> <p>- - -</p>
 <p><b>D 15-03</b> <b>Bench</b> <b>200 cm wide</b></p> <p>Total height: 47 cm Total width: 200 cm Total depth: 51 cm Seat height: 47 cm Seat width: 200 cm Seat depth: 47 cm Fabric req.: 2.2 m Leather req.: 3.1 m<sup>2</sup></p>					
	<p><b>Price gr.</b> I II III</p>	<p>D 1503....</p> <p>- - -</p>	<p>D 1503....</p> <p>- - -</p>	<p>D 1503....</p> <p>- - -</p>	<p>D 1503....</p> <p>- - -</p>
 <p><b>D 15-04</b> <b>Bench</b> <b>220 cm wide</b></p> <p>Total height: 47 cm Total width: 220 cm Total depth: 51 cm Seat height: 47 cm Seat width: 220 cm Seat depth: 47 cm Fabric req.: 2.4 m Leather req.: 3.4 m<sup>2</sup></p>					
	<p><b>Price gr.</b> I II III</p>	<p>D 1504....</p> <p>- - -</p>	<p>D 1504....</p> <p>- - -</p>	<p>D 1504....</p> <p>- - -</p>	<p>D 1504....</p> <p>- - -</p>

# BENCHES D 15

Please be sure to state the **model no. of the substructure wood version** in your order!

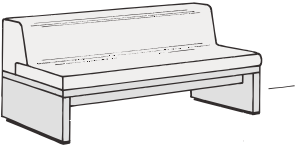
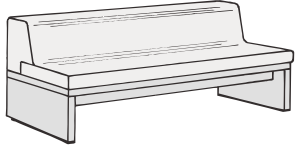
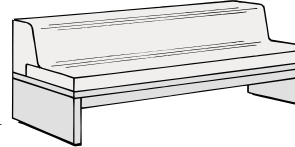
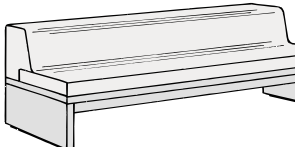
		Structured fabric (63..) Chenille »floral« (69..) Cotton-wool-Jacquard (75..) Woven Jacquard (82..) Woven Jacquard glossy (83..)	Velour CS (62..) Structured fabric »pure« (77..)	Leather (51..) »Dinamica« (68..) Wool fabric (80..)	Saddle leather (65..) Leather »metallic« (79..)
 <p><b>D 15-1</b> <b>Bench</b> <b>160 cm wide</b></p> <p>Total height: 77 cm Total width: 160 cm Total depth: 60 cm Seat height: 47 cm Seat width: 160 cm Seat depth: 47 cm Fabric req.: 3.4 m Leather req.: 5.4 m<sup>2</sup></p>					
	Price gr. I II III	D 151.... - - -	D 151.... - - -	D 151.... - - -	D 151.... - - -
 <p><b>D 15-2</b> <b>Bench</b> <b>180 cm wide</b></p> <p>Total height: 77 cm Total width: 180 cm Total depth: 60 cm Seat height: 47 cm Seat width: 180 cm Seat depth: 47 cm Fabric req.: 3.8 m Leather req.: 5.7 m<sup>2</sup></p>					
	Price gr. I II III	D 152.... - - -	D 152.... - - -	D 152.... - - -	D 152.... - - -
 <p><b>D 15-3</b> <b>Bench</b> <b>200 cm wide</b></p> <p>Total height: 77 cm Total width: 200 cm Total depth: 60 cm Seat height: 47 cm Seat width: 200 cm Seat depth: 47 cm Fabric req.: 4.2 m Leather req.: 6.3 m<sup>2</sup></p>					
	Price gr. I II III	D 153.... - - -	D 153.... - - -	D 153.... - - -	D 153.... - - -
 <p><b>D 15-4</b> <b>Bench</b> <b>220 cm wide</b></p> <p>Total height: 77 cm Total width: 220 cm Total depth: 60 cm Seat height: 47 cm Seat width: 220 cm Seat depth: 47 cm Fabric req.: 4.6 m Leather req.: 7.1 m<sup>2</sup></p>					
	Price gr. I II III	D 154.... - - -	D 154.... - - -	D 154.... - - -	D 154.... - - -

# BENCHES D 15

Please be sure to state the **model no. of the substructure wood version** in your order!

# DINING ROOMS

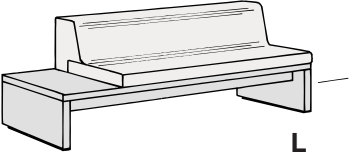
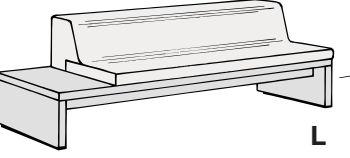
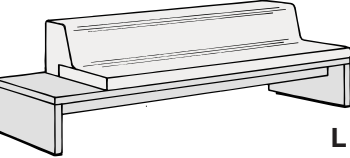
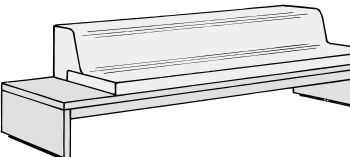
		Structured fabric (63..) Chenille »floral« (69..) Cotton-wool-Jacquard (75..) Woven Jacquard (82..) Wool fabric glossy (83..)	Velour CS (62..) Structured fabric »pure« (77..)	Leather (51..) »Dinamica« (68..) Wool fabric (80..)	Saddle leather (65..) Leather »metallic« (79..)
 <p style="text-align: right;"><b>L</b></p>	<p><b>D 15-5</b> Bench with side shelf 160 + 40 cm wide</p> <p>Total height: 77 cm Total width: 200 cm Total depth: 60 cm Seat height: 47 cm Seat width: 160 cm Seat depth: 47 cm Fabric req.: 3.4 m Leather req.: 5.4 m<sup>2</sup></p>	<p>D 1551.... L D 1552.... R</p>	<p>D 1551.... L D 1552.... R</p>	<p>D 1551.... L D 1552.... R</p>	<p>D 1551.... L D 1552.... R</p>
 <p style="text-align: right;"><b>L</b></p>	<p><b>D 15-6</b> Bench with side shelf 180 + 40 cm wide</p> <p>Total height: 77 cm Total width: 220 cm Total depth: 60 cm Seat height: 47 cm Seat width: 180 cm Seat depth: 47 cm Fabric req.: 3.8 m Leather req.: 5.7 m<sup>2</sup></p>	<p>D 1561.... L D 1562.... R</p>	<p>D 1561.... L D 1562.... R</p>	<p>D 1561.... L D 1562.... R</p>	<p>D 1561.... L D 1562.... R</p>
 <p style="text-align: right;"><b>L</b></p>	<p><b>D 15-7</b> Bench with side shelf 200 + 40 cm wide</p> <p>Total height: 77 cm Total width: 240 cm Total depth: 60 cm Seat height: 47 cm Seat width: 200 cm Seat depth: 47 cm Fabric req.: 4.2 m Leather req.: 6.3 m<sup>2</sup></p>	<p>D 1571.... L D 1572.... R</p>	<p>D 1571.... L D 1572.... R</p>	<p>D 1571.... L D 1572.... R</p>	<p>D 1571.... L D 1572.... R</p>
 <p style="text-align: right;"><b>L</b></p>	<p><b>D 15-8</b> Bench with side shelf 220 + 40 cm wide</p> <p>Total height: 77 cm Total width: 260 cm Total depth: 60 cm Seat height: 47 cm Seat width: 220 cm Seat depth: 47 cm Fabric req.: 4.6 m Leather req.: 7.1 m<sup>2</sup></p>	<p>D 1581.... L D 1582.... R</p>	<p>D 1581.... L D 1582.... R</p>	<p>D 1581.... L D 1582.... R</p>	<p>D 1581.... L D 1582.... R</p>

# BENCHES D 15

Please be sure to state the **model no. of the substructure wood version** in your order!

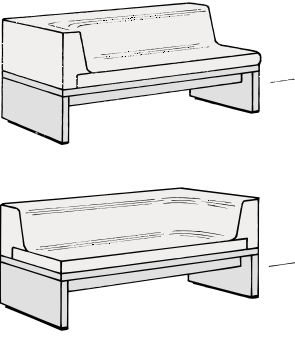
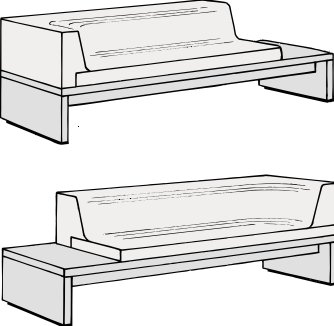
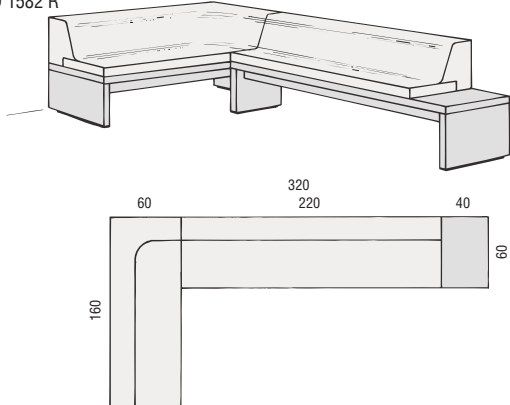
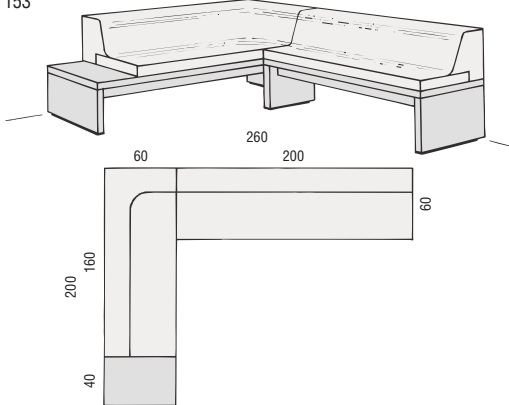
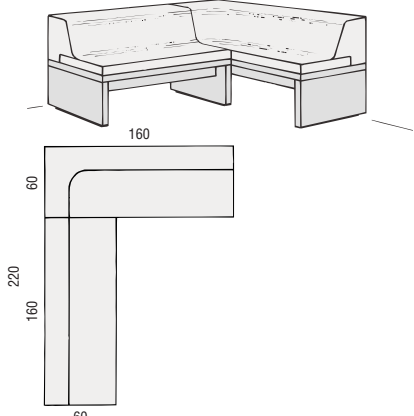
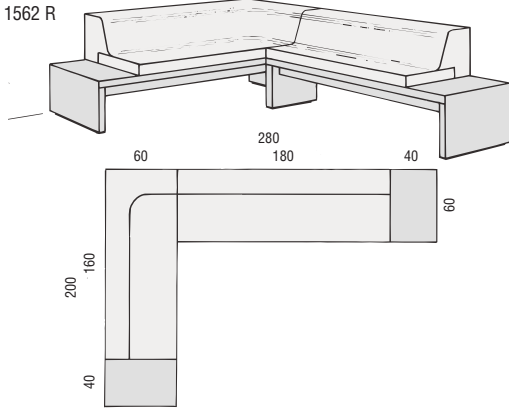
		Structured fabric (63..) Chenille »floral« (69..) Cotton-wool-Jacquard (75..) Woven Jacquard (82..) Woven Jacquard glossy (83..)	Velour CS (62..) Structured fabric »pure« (77..)	Leather (51..) »Dinamica« (68..) Wool fabric (80..)	Saddle leather (65..) Leather »metallic« (79..)
 <p><b>D 15-9</b> Corner bench 160 cm wide</p> <p>Total height: 77 cm Total width: 160 cm Total depth: 60 cm Seat height: 47 cm Seat width: 145 cm Seat depth: 47 cm Fabric req.: 3.7 m Leather req.: 6.2 m<sup>2</sup></p>					
	<p>Price gr. I II III</p>	<p>D 1591.... L D 1592.... R</p> <p>- - -</p>	<p>D 1591.... L D 1592.... R</p> <p>- - -</p>	<p>D 1591.... L D 1592.... R</p> <p>- - -</p>	<p>D 1591.... L D 1592.... R</p> <p>- - -</p>
 <p><b>D 15-10</b> Corner bench with side shelf 160 + 40 cm wide</p> <p>Total height: 77 cm Total width: 200 cm Total depth: 60 cm Seat height: 47 cm Seat width: 145 cm Seat depth: 47 cm Fabric req.: 3.7 m Leather req.: 6.2 m<sup>2</sup></p>					
	<p>Price gr. I II III</p>	<p>D 15101.... L D 15102.... R</p> <p>- - -</p>	<p>D 15101.... L D 15102.... R</p> <p>- - -</p>	<p>D 15101.... L D 15102.... R</p> <p>- - -</p>	<p>D 15101.... L D 15102.... R</p> <p>- - -</p>
<p><b>Practical example 1</b> Bench D 1592 R and D 1582 R</p> 	<p><b>Practical example 2</b> Bench D 15102 R and D 153</p> 				
<p><b>Practical example 3</b> Bench D 151 and D 1591 L</p> 	<p><b>Practical example 4</b> Bench D 15102 R and D 1562 R</p> 				

# D 16

## Gentle curves in a clear design form

The intricately perfected details underline the clear form of design of this chair and bar stool. Rectangular tubular steel, set upright, and formed wooden seat bowls that match the given design form absolutely perfectly harmonise to form a complete entity. Gentle curves flow into straight lines and uncomplicated upholstered surfaces mean that this chair generates a peaceful and gentle radiance.

### Product spectrum:

- Seat bowls made of formed wood (D 16-1 to D 16-4) or with upholstered seats (D 16-5 to D 16-8)
- Chair model with and without armrests
- The bar stool comes with a small arched back section providing gentle support. The semi-high backrest of formed wood therefore allows you to lean back and relax.

### Product features:

- Formed wooden bowls and upholstered seats meet a metal substructure
- Formed wooden seats 8 mm thick
- Substructure made of rectangular tubular steel 30x10x2 mm or 35x10x2 mm
- Plastic and felt gliders are included (for hard and soft floors)

### Metal surfaces

- High-gloss chrome
- Matt chrome

### Cover materials (D 16-5 to D 16-8)

- High-grade leather in contemporary colours
- Microfibre "Dinamica" in homely colours
- Modern textile cover fabrics, easy-to-care for with high-quality protection against soiling
- Customer's fabrics possible (price group = best fabric price group)

### Surface coating of armrests (D 16-5 to D 16-8):

For leather: in the corresponding leather colour  
 For Dinamica: in the corresponding Dinamica colour  
 For velour: in the corresponding velour colour  
 For structured fabric »pure«: in the corresponding structured fabric colour  
 For textile cover fabrics:



in 5105 (black leather) for	6302	6304	6305	6901	8001	8004
in 5109 (cream leather) for	7501	8002				
in 5101 (beige leather) for	7502	8201				
in 5104 (anthracite leather) for	7504	7505	8204	8206	8207	8303
in 5110 (mocca leather) for	6301	6303	7503	8203	8205	
in 5114 (grey-brown leather) for	8003					
in 5122 (sand leather) for	8301					
in 5123 (brown-black leather) for	8302					



### List of versions Formed wooden seat (D 16-1 to D 16-4)

Model no.	Version
116	Oak anthracite
115	Oak mocca
118	Walnut
120	White lacquer

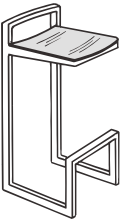
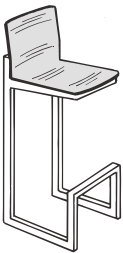

Please be sure to state the **model no. of the formed wooden seat version** in your order!

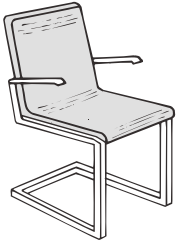
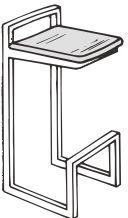
 <p><b>D 16-1</b> <b>Wooden chair</b> Substructure versions: high-gloss chrome/ matt chrome</p> <p>Total height: 85.0 cm Total width: 46.0 cm Total depth: 57.0 cm Seat height: 44.0 cm Seat width: 46.0 cm Seat depth: 45.5 cm</p>	Substructure version: High-gloss chrome	<b>D 1612....</b> -
	Substructure version: Matt chrome	<b>D 1613....</b> -
 <p><b>D 16-2</b> <b>Wooden chair with armrests</b> Substructure versions: high-gloss chrome/ matt chrome</p> <p>Total height: 85.0 cm Total width: 53.0 cm Total depth: 57.0 cm Seat height: 44.0 cm Seat width: 46.0 cm Seat depth: 45.5 cm Armrest height: 64.0 cm</p>	Substructure version: High-gloss chrome	<b>D 1622....</b> -
	Substructure version: Matt chrome	<b>D 1623....</b> -
 <p><b>D 16-3</b> <b>Bar stool with arched support</b> Substructure versions: high-gloss chrome/ matt chrome</p> <p>Total height: 90.0 cm Total width: 41.0 cm Total depth: 43.0 cm Seat height: 80.0 cm Seat width: 36.0 cm Seat depth: 36.0 cm</p>	Substructure version: High-gloss chrome	<b>D 1632....</b> -
	Substructure version: Matt chrome	<b>D 1633....</b> -
 <p><b>D 16-4</b> <b>Bar stool with backrest</b> Substructure versions: high-gloss chrome/ matt chrome</p> <p>Total height: 100.0 cm Total width: 41.0 cm Total depth: 43.0 cm Seat height: 80.0 cm Seat width: 36.0 cm Seat depth: 36.0 cm</p>	Substructure version: High-gloss chrome	<b>D 1642....</b> -
	Substructure version: Matt chrome	<b>D 1643....</b> -

 <p><b>D 16-5</b>  <b>Upholstered chair</b>                  Substructure versions: high-gloss chrome/                  matt chrome</p> <p>Total height: 86.0 cm                  Total width: 46.0 cm                  Total depth: 57.0 cm                  Seat height: 44.0 cm                  Seat width: 46.0 cm                  Seat depth: 45.5 cm</p>		Structured fabric (63..) Chenille »floral« (69..) Cotton-wool-Jacquard (75..) Woven Jacquard (82..) Woven Jacquard glossy (83..)	Velour CS (62..) Structured fabric »pure« (77..)	Leather (51..) »Dinamica« (68..) Wool fabric (80..)	Saddle leather (65..) Leather »metallic« (79..)
	Substructure version: High-gloss chrome	<b>D 1652....</b>	<b>D 1652....</b>	<b>D 1652....</b>	<b>D 1652....</b>
		-	-	-	-
	Substructure version: Matt chrome	<b>D 1653....</b>	<b>D 1653....</b>	<b>D 1653....</b>	<b>D 1653....</b>
		-	-	-	-
 <p><b>D 16-6</b>  <b>Upholstered chair with armrests</b>                  Substructure versions: high-gloss chrome/                  matt chrome</p> <p>Total height: 86.0 cm                  Total width: 53.0 cm                  Total depth: 57.0 cm                  Seat height: 44.0 cm                  Seat width: 46.0 cm                  Seat depth: 45.5 cm                  Armrest height: 64.0 cm</p>		Structured fabric (63..) Chenille »floral« (69..) Cotton-wool-Jacquard (75..) Woven Jacquard (82..) Woven Jacquard glossy (83..)	Velour CS (62..) Structured fabric »pure« (77..)	Leather (51..) »Dinamica« (68..) Wool fabric (80..)	Saddle leather (65..) Leather »metallic« (79..)
	Substructure version: High-gloss chrome	<b>D 1662....</b>	<b>D 1662....</b>	<b>D 1662....</b>	<b>D 1662....</b>
		-	-	-	-
	Substructure version: Matt chrome	<b>D 1663....</b>	<b>D 1663....</b>	<b>D 1663....</b>	<b>D 1663....</b>
		-	-	-	-
 <p><b>D 16-7</b>  <b>Upholstered bar stool with arched support</b>                  Substructure versions: high-gloss chrome/                  matt chrome</p> <p>Total height: 90.0 cm                  Total width: 41.0 cm                  Total depth: 43.0 cm                  Seat height: 80.0 cm                  Seat width: 36.0 cm                  Seat depth: 36.0 cm</p>		Structured fabric (63..) Chenille »floral« (69..) Cotton-wool-Jacquard (75..) Woven Jacquard (82..) Woven Jacquard glossy (83..)	Velour CS (62..) Structured fabric »pure« (77..)	Leather (51..) »Dinamica« (68..) Wool fabric (80..)	Saddle leather (65..) Leather »metallic« (79..)
	Substructure version: High-gloss chrome	<b>D 1672....</b>	<b>D 1672....</b>	<b>D 1672....</b>	<b>D 1672....</b>
		-	-	-	-
	Substructure version: Matt chrome	<b>D 1673....</b>	<b>D 1673....</b>	<b>D 1673....</b>	<b>D 1673....</b>
		-	-	-	-
 <p><b>D 16-8</b>  <b>Upholstered bar stool with backrest</b>                  Substructure versions: high-gloss chrome/                  matt chrome</p> <p>Total height: 100.0 cm                  Total width: 41.0 cm                  Total depth: 43.0 cm                  Seat height: 80.0 cm                  Seat width: 36.0 cm                  Seat depth: 36.0 cm</p>		Structured fabric (63..) Chenille »floral« (69..) Cotton-wool-Jacquard (75..) Woven Jacquard (82..) Woven Jacquard glossy (83..)	Velour CS (62..) Structured fabric »pure« (77..)	Leather (51..) »Dinamica« (68..) Wool fabric (80..)	Saddle leather (65..) Leather »metallic« (79..)
	Substructure version: High-gloss chrome	<b>D 1682....</b>	<b>D 1682....</b>	<b>D 1682....</b>	<b>D 1682....</b>
		-	-	-	-
	Substructure version: Matt chrome	<b>D 1683....</b>	<b>D 1683....</b>	<b>D 1683....</b>	<b>D 1683....</b>
		-	-	-	-

# D 17 **Comfort meets wood**

A simple yet graceful wooden substructure with visible connecting elements on the armrests forms a contradictory and yet fascinating combination with the soft upholstery. Contemporary in-trend woods and high-quality cover materials meet all your individual requirements with regard to design.

### Product spectrum

- The chair is supplied in one backrest height with an optional armrest
- Different solid wooden versions to choose from

### Product features

- Substructure constructed of solid wood
- Leisurely, comfortable seat and rear upholstery
- Upholstery composition: high-quality rubber belt, padded foam layer RG 5050 and a down-filled cushion with a ratio of 35% to 65% (down/padding)
- Solid wooden legs
- Plastic and felt gliders are included (for hard and soft floors)



### Cover materials

- High-grade leather in contemporary colours
- Microfibre “Dinamica” in homely colours
- Modern textile cover fabrics, easy-to-care for with high-quality protection against soiling
- Customer’s fabrics possible (price group = best fabric price group)



### List of versions Substructure

Model no.	Version	Price group
110	Solid beech	I
116	Solid oak anthracite	I
117	Solid natural oak	I
111	Solid alder	II
113	Solid Cherrywood gold	II
118	Solid walnut	II

Please be sure to state the **model no. of the substructure wood version** in your order!

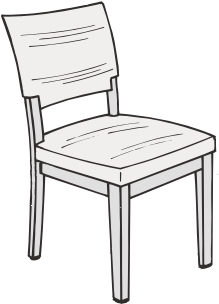
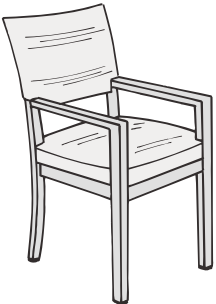
		Structured fabric (63..) Chenille »floral« (69..) Cotton-wool-Jacquard (75..) Woven Jacquard (82..) Woven Jacquard glossy (83..)	Velour CS (62..) Structured fabric »pure« (77..)	Leather (51..) »Dinamica« (68..) Wool fabric (80..)	Saddle leather (65..) Leather »metallic« (79..)
 <p><b>D 17-1</b> Upholstered chair</p> <p>Total height: 91.0 cm Total width: 51.0 cm Total depth: 59.0 cm Seat height: 53.0 cm Seat width: 51.0 cm Seat depth: 50.0 cm Fabric req.: 1.3 m Leather req.: 2.1 m<sup>2</sup></p>					
		<b>D 171....</b>	<b>D 171....</b>	<b>D 171....</b>	<b>D 171....</b>
	<b>Price gr.</b> I II	- -	- -	- -	- -
 <p><b>D 17-2</b> Upholstered chair with wooden armrests</p> <p>Total height: 91.0 cm Total width: 57.0 cm Total depth: 59.0 cm Seat height: 53.0 cm Seat width: 49.0 cm Seat depth: 50.0 cm Armrest height: 64.0 cm Fabric req.: 1.3 m Leather req.: 2.3 m<sup>2</sup></p>					
		<b>D 172....</b>	<b>D 172....</b>	<b>D 172....</b>	<b>D 172....</b>
	<b>Price gr.</b> I II	- -	- -	- -	- -

## D 18 The classic one in a new dress

This free swinging chair has a tailor-made cover completely without seams to reveal the interplay of transparent and opaque surfaces to best effect. The cover seems to gently embrace the sub-structure - so that the seat surface and the backrest are connected in a gentle curve to form a single entity. The effect is achieved by means of mesh mantle, in which every single aperture is exactly positioned: holes for connections, double rim seaming and darting are simply integrated.

### Product spectrum

- Quality not quantity: there is an optional metal armrest
- Even more comfortable: seat with foam padding

### Product features

- Interflowing backrest and seat - no annoying seams
- Contrasting interplay of transparent and opaque surfaces
- Formed cord of hard-wearing Trevira polyester yarn in many different colours
- Trevira polyester yarn: easy to care for, breathes actively, stable in form and dirt-resistant
- Plastic and felt gliders are included (for hard and soft floors)



### Important note:



The D 18 chair model is to be discontinued as of **31/05/2011** (last date for order acceptance at hülsta). This chair has been modified. See the new **D 18 plus** chair model on the following double page!

### Metal surfaces

- High-gloss chrome
- Matt chrome

### Cover materials

- Formed cord of Trevira polyester yarn in many different colours
- Customer's fabrics not possible

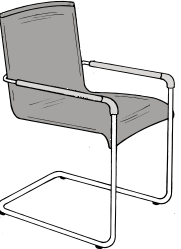
 <p><b>D 18-1</b> <b>Chair</b> Seat and backrest in a formed cord cover, transparent, and with a 4 cm wide opaque frame</p> <p>Substructure versions: high-gloss chrome/matt chrome</p> <p>Total height: 86.3 cm Total width: 55.5 cm Total depth: 61.7 cm Seat height: 48.3 cm Seat width: 49.6 cm Seat depth: 45.6 cm</p>		Formed cord (81..)
	Substructure version: High-gloss chrome	D 1812.... -
	Substructure version: Matt chrome	D 1813.... -
 <p><b>D 18-2</b> <b>Chair with metal armrests</b> Seat and backrest in a formed cord cover, transparent, and with a 4 cm wide opaque frame</p> <p>Substructure versions: high-gloss chrome/matt chrome</p> <p>Total height: 86.3 cm Total width: 62.2 cm Total depth: 57.8 cm Seat height: 48.3 cm Seat width: 49.6 cm Seat depth: 45.6 cm Armrest height: 64.5 cm</p>	Substructure version: High-gloss chrome	D 1822.... -
	Substructure version: Matt chrome	D 1823.... -
 <p><b>D 18-3</b> <b>Chair</b> Seat and backrest in a formed cord cover, opaque seat surface and with foam padding</p> <p>Substructure versions: high-gloss chrome/matt chrome</p> <p>Total height: 86.3 cm Total width: 55.5 cm Total depth: 61.7 cm Seat height: 48.3 cm Seat width: 49.6 cm Seat depth: 45.6 cm</p>	Substructure version: High-gloss chrome	D 1832.... -
	Substructure version: Matt chrome	D 1833.... -
 <p><b>D 18-4</b> <b>Chair with metal armrests</b> Seat and backrest in a formed cord cover, opaque seat surface and with foam padding</p> <p>Substructure versions: high-gloss chrome/matt chrome</p> <p>Total height: 86.3 cm Total width: 62.2 cm Total depth: 57.8 cm Seat height: 48.3 cm Seat width: 49.6 cm Seat depth: 45.6 cm Armrest height: 64.5 cm</p>	Substructure version: High-gloss chrome	D 1842.... -
	Substructure version: Matt chrome	D 1843.... -

# D 18 plus

The classic one in a new dress

**NEW**

This free swinging chair has a tailor-made cover completely without seams to reveal the interplay of transparent and opaque surfaces to best effect. The cover seems to gently embrace the substructure - so that the seat surface and the backrest are connected in a gentle curve to form a single entity. The effect is achieved by means of mesh mantle, in which every single aperture is exactly positioned: holes for connections, double rim seaming and darting are simply integrated.

## Product spectrum

- Quality not quantity: there is an optional metal armrest with a solid wooden mantle
- Even more comfortable: seat with foam padding

## Product features

- Interflowing backrest and seat - no annoying seams
- Contrasting interplay of transparent and opaque surfaces
- Formed cord of hard-wearing Trevira polyester yarn in many different colours
- Trevira polyester yarn: easy to care for, breathes actively, stable in form and dirt-resistant
- Armrest of solid wood
- Plastic and felt gliders are included (for hard and soft floors)



## Metal surfaces

- High-gloss chrome
- Matt chrome

## Cover materials

- Formed cord of Trevira polyester yarn in many different colours
- Customer's fabrics not possible

## Lists of versions



### List of version Metal substructure version

Model no.	Version	Price group
131	High-gloss chrome	I
132	Matt chrome	II

### List of versions Solid wooden armrest mantle version

Model no.	Version
110	Beech
115	Oak mocca
117	Natural oak
122	Light brown ash
113	Cherrywood gold
123	Core walnut
120	White lacquer

Please be sure to state the model no. of the wood version of the armrests as well as the model no. of the metal version of the substructure in your order!

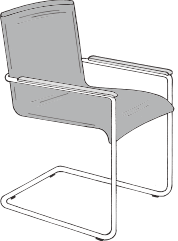
 <p><b>D 18-5</b> <b>Chair</b> Seat and backrest in a formed cord cover, transparent, and with a 4 cm wide opaque frame</p> <p>Substructure versions: high-gloss chrome/matt chrome</p> <p>Total height: 90.3 cm Total width: 50.5 cm Total depth: 61.7 cm Seat height: 47.3 cm Seat width: 44.6 cm Seat depth: 45.6 cm</p>	<p>Formed cord (81..)</p> <p><b>Price gr.</b> I II</p>	<p><b>D 185....</b> - -</p>
 <p><b>D 18-6</b> <b>Chair with metal armrests and solid wooden mantle</b> Seat and backrest in a formed cord cover, transparent, and with a 4 cm wide opaque frame</p> <p>Substructure versions: high-gloss chrome/matt chrome</p> <p>Total height: 90.3 cm Total width: 57.0 cm Total depth: 57.8 cm Seat height: 47.3 cm Seat width: 44.6 cm Seat depth: 45.6 cm Armrest height: 64.5 cm</p>	<p><b>Price gr.</b> I II</p>	<p><b>D 186....</b> - -</p>
 <p><b>D 18-7</b> <b>Chair</b> Seat and backrest in a formed cord cover, transparent, and with a 4 cm wide opaque frame. Opaque seat surface and with foam padding.</p> <p>Substructure versions: high-gloss chrome/matt chrome</p> <p>Total height: 90.3 cm Total width: 50.5 cm Total depth: 61.7 cm Seat height: 47.3 cm Seat width: 44.6 cm Seat depth: 45.6 cm</p>	<p><b>Price gr.</b> I II</p>	<p><b>D 187....</b> - -</p>
 <p><b>D 18-8</b> <b>Chair with metal armrests and solid wooden mantle</b> Seat and backrest in a formed cord cover, transparent, and with a 4 cm wide opaque frame. Opaque seat surface and with foam padding.</p> <p>Substructure versions: high-gloss chrome/matt chrome</p> <p>Total height: 90.3 cm Total width: 57.0 cm Total depth: 57.8 cm Seat height: 47.3 cm Seat width: 44.6 cm Seat depth: 45.6 cm Armrest height: 64.5 cm</p>	<p><b>Price gr.</b> I II</p>	<p><b>D 188....</b> - -</p>

## D 19 The gentle one

A small dining-room chair, which creates an attractive contrast to the mainly strict forms of the dining table with its gentle curves. This is further highlighted by the line of the intricate “Keder” seam of corded band.

### Product spectrum

- Seat frame with a mesh belt support spring  
- 6 extra wide belts of 50 mm
- Seat frame of rectangular tube, 15x2 mm
- Back frame of cylindrical tube, Ø 14 mm
- Sides of rectangular tube 15 mm and cylindrical tube, Ø 14 mm
- Upholstery of high-quality, hard-wearing PU cold foam
- Increased comfort by way of suspended backrest
- Volume weight 60 - 65 kg/m<sup>3</sup>
- Cover fabrics: woven Jacquard, woven Jacquard glossy, leather and saddle leather
- Seam of corded cotton band
- Plastic and felt gliders are included (for hard and soft floors)



### Cover materials

- Woven Jacquard: composition: 82% PES, 18% LN
- Woven Jacquard glossy: composition: 54% VIS, 15% PES, 14% LN, 14% CO, 3% PA
- Leather and saddle leather
- Seam of corded cotton band, seam colour optionally in white, mocca or black
- Customer's fabrics not possible

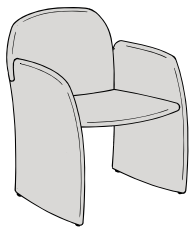

**D 19-1**

**Upholstered armchair**

Total height: 81.0 cm  
 Total width: 62.0:60.0 cm  
 Total depth: 59.0 cm  
 Seat height: 46.5 cm  
 Seat width: 49.0 cm  
 Seat depth: 45 cm  
 Armrest height: max. 64.5 cm

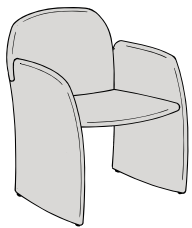
		Woven Jacquard (82..) Woven Jacquard glossy (83..)	Leather (51..)	Saddle leather (65..)
 <p><b>D 19-1</b></p> <p><b>Upholstered armchair</b></p> <p>Total height: 81.0 cm                      Total width: 62.0:60.0 cm                      Total depth: 59.0 cm                      Seat height: 46.5 cm                      Seat width: 49.0 cm                      Seat depth: 45 cm                      Armrest height: max. 64.5 cm</p>	Seam colour white	<b>D 1911....</b> -	<b>D 1911....</b> -	<b>D 1911....</b> -
	Seam colour mocca	<b>D 1912....</b> -	<b>D 1912....</b> -	<b>D 1912....</b> -
	Seam colour black	<b>D 1913....</b> -	<b>D 1913....</b> -	<b>D 1913....</b> -

## D 20 The variable one

Clarity and straightforwardness hallmark the design of the seat bowl – the essential basis for longevity and also the right basis for being able to present itself in a different look involving a variety of types of wood and cover materials. The seat and the substructure correspond in a well-balanced and harmonious way: the proportions are correct, the form of design is clear and comprehensible. The all-leather version of the D 20 chair has a particularly pure and high-quality look: the seat bowl and the substructure are all covered with a type of leather of your choice.

The model D 20 provides you with a number of ways of putting together "your" chair.

### Product spectrum

- 2 different chair models:
  - D 20 with solid wooden substructure:** substructure in various types of solid wood, seat, back and upholstered armrests with different cover materials
  - D 20 with an all-leather cover:** substructure (with solid beech core), seat, back and upholstered armrests with all-leather cover, in all types and colours of leather
- Individual combination of seat bowl:
  - 2 backrest heights: low and high
  - 2 seat widths: standard seat width 44/46 cm, comfort seat width 48/50 cm
  - 3 seat comfort levels: sewn-on seat cushion in firm – medium – soft (with a "loose cushion look")
- Armrest versions: without armrests, with closed upholstered armrests or with open wooden armrests
- Plastic and felt gliders are included (for hard and soft floors)



### Product features

- **Seat bowl:**
  - base construction: solid wooden substructure; a rubber belt spring forms the basis for the upholstery, the belts are fastened firmly to the solid wooden substructure
  - backrest function: use of spring steel – yields to pressure and adapts to the body. Belt cover with foam padding RG 2535
  - rear upholstery: polyether foam RG 5050
  - seat upholstery: the base of the seat consists of polyether foam RG 4070
- **Seat comfort levels of cushions:** (in "loose cushion look"; fastened firmly to the seat frame):
  - A – Firm:** spring core cushion  
Intensive seat support; the spring core cushion (cylinder pocket springs, wire strength 1.6 cm) is embedded in a frame of polyether foam, RG 4070. Covered with a polyether foam material.
  - B – Medium:** cold foam cushion  
Comfortable seat support; polyether foam RG 5040 HR
  - C – Soft:** spring flex cushion  
Gentle seat support: mixture of springs and foam sticks cut in small lengths (form retention level 4.6 kpa). The springs, proportion of 35%, have a lubricating and gliding function in the cushion, the loose foam sticks give the cushion its shape.





Please be sure to state the **model no. of the substructure wood version** as well as the **padding for the cushion and the seat width** in your order! Please note the example of order on page 69!

# CHAIRS D 20 with solid wooden substructure

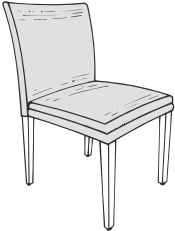
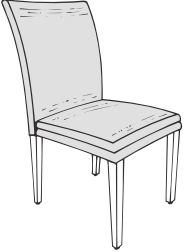
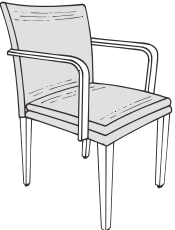
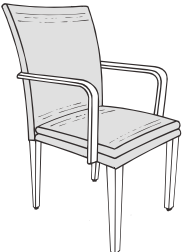
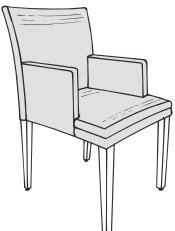
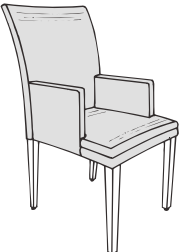
		Structured fabric (63..) Chenille »floral« (69..) Cotton-wool-Jacquard (75..) Woven Jacquard (82..) Glossy (83..)	Velour CS (62..) Structured fabric »pure« (77..)	Leather (51..) »Dinamica« (68..) Wool fabric (80..)	Saddle leather (65..) Leather »metallic« (79..)
 <p><b>D 20-1</b> Upholstered chair with low backrest</p> <p>Total height: 85.5 cm Total width: see seat width Total depth: 57.0 cm Seat height: 49.0 cm Seat width: 46 or 50 cm Seat depth: 46.0 cm Fabric req.: 1.44 m Leather req.: 1.85 m<sup>2</sup></p>					
	Price gr. I II III	D 201.... - - -	D 201.... - - -	D 201.... - - -	D 201.... - - -
 <p><b>D 20-2</b> Upholstered chair with high backrest</p> <p>Total height: 94.5 cm Total width: see seat width Total depth: 57.0 cm Seat height: 49.0 cm Seat width: 46 or 50 cm Seat depth: 46.0 cm Fabric req.: 1.44 m Leather req.: 2.05 m<sup>2</sup></p>					
	Price gr. I II III	D 202.... - - -	D 202.... - - -	D 202.... - - -	D 202.... - - -
 <p><b>D 20-3</b> Upholstered chair with low backrest and wooden armrests</p> <p>Total height: 85.5 cm Total width: see seat width + 6 cm Total depth: 57.0 cm Seat height: 49.0 cm Seat width: 46 or 50 cm Seat depth: 46.0 cm Armrest height: 64.5 cm Fabric req.: 1.44 m Leather req.: 1.85 m<sup>2</sup></p>					
	Price gr. I II III	D 203.... - - -	D 203.... - - -	D 203.... - - -	D 203.... - - -
 <p><b>D 20-4</b> Upholstered chair with high backrest and wooden armrests</p> <p>Total height: 94.5 cm Total width: see seat width + 6 cm Total depth: 57.0 cm Seat height: 49.0 cm Seat width: 46 or 50 cm Seat depth: 46.0 cm Armrest height: 64.5 cm Fabric req.: 1.44 m Leather req.: 2.05 m<sup>2</sup></p>					
	Price gr. I II III	D 204.... - - -	D 204.... - - -	D 204.... - - -	D 204.... - - -
 <p><b>D 20-5</b> Upholstered chair with low backrest and upholstered armrests</p> <p>Total height: 85.5 cm Total width: see seat width + 6 cm Total depth: 57.0 cm Seat height: 49.0 cm Seat width: 44 or 48 cm Seat depth: 46.0 cm Armrest height: 64.5 cm Fabric req.: 1.9 m Leather req.: 2.9 m<sup>2</sup></p>					
	Price gr. I II III	D 205.... - - -	D 205.... - - -	D 205.... - - -	D 205.... - - -
 <p><b>D 20-6</b> Upholstered chair with high backrest and upholstered armrests</p> <p>Total height: 94.5 cm Total width: see seat width + 6 cm Total depth: 57.0 cm Seat height: 49.0 cm Seat width: 44 or 48 cm Seat depth: 46.0 cm Armrest height: 64.5 cm Fabric req.: 1.9 m Leather req.: 3,1 m<sup>2</sup></p>					
	Price gr. I II III	D 206.... - - -	D 206.... - - -	D 206.... - - -	D 206.... - - -

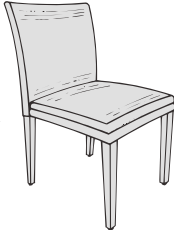
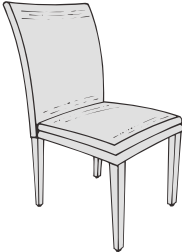
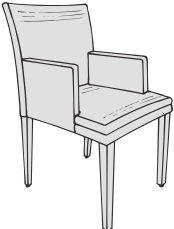
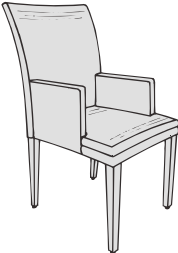
		Leather (51..)	Saddle leather (65..) Leather »metallic« (79..)
 <p><b>D 20-7</b>  <b>Upholstered chair with low backrest</b>                      Total height: 85.5 cm                      Total width: see seat width                      Total depth: 57.0 cm                      Seat height: 49.0 cm                      Seat width: 46 or 50 cm                      Seat depth: 46.0 cm                      Leather req.: 2.45 m<sup>2</sup></p>		D 207.... -	D 207.... -
 <p><b>D 20-8</b>  <b>Upholstered chair with high backrest</b>                      Total height: 94.5 cm                      Total width: see seat width                      Total depth: 57.0 cm                      Seat height: 49.0 cm                      Seat width: 46 or 50 cm                      Seat depth: 46.0 cm                      Leather req.: 2.65 m<sup>2</sup></p>		D 208.... -	D 208.... -
 <p><b>D 20-9</b>  <b>Upholstered chair with low backrest and upholstered armrests</b>                      Total height: 85.5 cm                      Total width: see seat width + 6 cm                      Total depth: 57.0 cm                      Seat height: 49.0 cm                      Seat width: 44 or 48 cm                      Seat depth: 46.0 cm                      Armrest height: 64.5 cm                      Leather req.: 3.5 m<sup>2</sup></p>		D 209.... -	D 209.... -
 <p><b>D 20-10</b>  <b>Upholstered chair with high backrest and upholstered armrests</b>                      Total height: 94.5 cm                      Total width: see seat width + 6 cm                      Total depth: 57.0 cm                      Seat height: 49.0 cm                      Seat width: 44 or 48 cm                      Seat depth: 46.0 cm                      Armrest height: 64.5 cm                      Leather req.: 3.7 m<sup>2</sup></p>		D 2010.... -	D 2010.... -

## D 21 **The simple one**

In this model we have followed the principle of simplicity: a comprehensible form of design without any unnecessary gimmicks. Soft curves meet straight lines: the result is a chair in a clear form of design. The thick upholstery promises the user a high level of comfort and lots of different types of wood for the solid wooden chair legs enable the owner to adapt the chairs to match his existing dining room suite.

### Product spectrum

- 2 backrest heights
- Chair with or without wooden armrests
- Substructure construction of solid wood, narrowing downwards
- Plastic and felt gliders are included (for hard and soft floors)

### Product features

- Seat bowl:  
base construction: solid wooden substructure; a rubber belt spring forms the basis for the upholstery, the belts are fastened firmly to the solid wooden substructure  
backrest function: use of spring steel – yields to pressure and adapts to the body. Belt cover with foam padding RG 2535  
rear upholstery: polyether foam RG 5050  
seat upholstery: the base of the seat consists of polyether foam RG 4070. The seat core consists of a cold polyether foam RG 5040



### Cover materials

- High-grade leather in contemporary colours
- Microfibre “Dinamica” in homely colours
- Modern textile cover fabrics, easy-to-care for with high-quality protection against soiling
- Customer’s fabrics possible (price group = best fabric price group)



### List of versions Substructure

Model no.	Version	Price group
110	Solid beech	I
111	Solid alder	II
112	Solid natural maple	II
115	Solid oak mocca	II
116	Solid oak anthracite	II
117	Solid natural oak	II
122	Solid light brown ash	II
113	Solid Cherrywood gold	III
118	Solid walnut	III

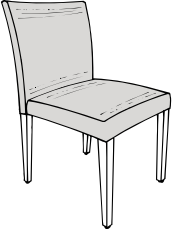
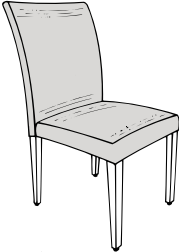
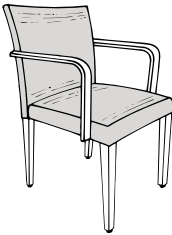
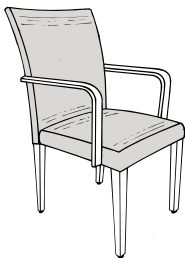
		Structured fabric (63..) Chenille »floral« (69..) Cotton-wool-Jacquard (75..) Woven Jacquard (82..) Woolen Jacquard glossy (83..)	Velour CS (62..) Structured fabric »pure« (77..)	Leather (51..) »Dinamica« (68..) Wool fabric (80..)	Saddle leather (65..) Leather »metallic« (79..)
 <p><b>D 21-1</b> Upholstered chair with low backrest</p> <p>Total height: 85.5 cm Total width: 46.0 cm Total depth: 57.0 cm Seat height: 49.0 cm Seat width: 46.0 cm Seat depth: 46.0 cm Fabric req.: 1.44 m Leather req.: 1.85 m<sup>2</sup></p>		D 211....	D 211....	D 211....	D 211....
	Price gr. I II III	- - -	- - -	- - -	- - -
 <p><b>D 21-2</b> Upholstered chair with high backrest</p> <p>Total height: 94.5 cm Total width: 46.0 cm Total depth: 57.0 cm Seat height: 49.0 cm Seat width: 46.0 cm Seat depth: 46.0 cm Fabric req.: 1.44 m Leather req.: 2.05 m<sup>2</sup></p>		D 212....	D 212....	D 212....	D 212....
	Price gr. I II III	- - -	- - -	- - -	- - -
 <p><b>D 21-3</b> Upholstered chair with low backrest and wooden armrests</p> <p>Total height: 85.5 cm Total width: 50.0 cm Total depth: 57.0 cm Seat height: 49.0 cm Seat width: 44.0 cm Seat depth: 46.0 cm Armrest height: 64.5 cm Fabric req.: 1.44 m Leather req.: 1.85 m<sup>2</sup></p>		D 213....	D 213....	D 213....	D 213....
	Price gr. I II III	- - -	- - -	- - -	- - -
 <p><b>D 21-4</b> Upholstered chair with high backrest and wooden armrests</p> <p>Total height: 94.5 cm Total width: 50.0 cm Total depth: 57.0 cm Seat height: 49.0 cm Seat width: 44.0 cm Seat depth: 46.0 cm Armrest height: 64.5 cm Fabric req.: 1.44 m Leather req.: 2.05 m<sup>2</sup></p>		D 214....	D 214....	D 214....	D 214....
	Price gr. I II III	- - -	- - -	- - -	- - -